



FOLLOW US

Discover.

Inspiration in the right angle.

#FEELMOREWOW

G*GRASS[®]

MOVEMENT SYSTEMS, FITTINGS AND ACCESSORIES

07/2023

We operate all over the world, wherever our customers call home. Because customer proximity is an expression of our corporate culture.



Developing complex movement systems takes an efficient team combined with the passion and desire to work together and transform ideas into something new. This is our traditional way of thinking at GRASS. **Movement is our passion.**



The GRASS Group is a globally successful corporate group, a traditional yet fresh brand with an impressive variety of perspectives. With around 1860 employees across 19 locations and more than 200 sales partners in 60 countries, GRASS ranks among the world's leading specialists in movement systems.

Sales and production

locations in Germany

Production Facility, Reinheim
Sales Office, Reinheim
Sales Office, Voralberg

Locations in Austria:

Logistics Centre, Hohenems
Sales Office, Hohenems
Production Facility, Höchst
Production Facility, Götzis
Production Facility, Salzburg

State-of-the-art customer and logistics centre

With a total investment of 70 million euros, the customer and logistics centre is not only the largest investment in the company's history, but also the most modern distribution centre in the Würth Group. The figures for the new logistics site speak for themselves: The eleven-aisle high-bay warehouse is 22 levels tall, with over 600 racking uprights to accommodate almost 38,000 pallet storage spaces. The site incorporates over 5000 tonnes of steel, and the longest façade measures more than 180 metres. The building covers an area of 11,150 m².



New hybrid picking system ensures optimum loading and unloading.

A custom warehouse management system has been developed for GRASS, featuring a material flow computer, forklift control system and mobile device integration. This system operates independently in the incoming goods area: when trucks dock, the fully automatic system accepts the pallets via a state-of-the-art floor conveyor without human intervention. A truck can be completely unloaded in just two minutes with this process. For outgoing goods, orders are presequenced using two separate, double-deep shipping buffers. Items for an order are removed "heavy before light" in order to optimise loading onto the truck.



Since 2004, GRASS has been part of the international Würth Group, which has an annual turnover of more than 19 billion euros and is the world leader in the trade of assembly and fastening materials.

MEMBER OF THE
WÜRTH  GROUP

QUALITY@GRASS

Quality begins with development.

Ideas can only become innovations if they can be produced in series at the highest level. Our engineers rely on all the benefits of modern development and production technology to manufacture these product ideas. Production and development departments work closely together across locations to guarantee the continuous optimisation of all production processes.



"We recognise our responsibility to provide customers with the outstanding product quality they expect."

Werner Elender
COO GRASS Group

QUALITY@GRASS

Technical precision, durability, functionality, design and environmental consciousness all come together to form a highly sophisticated quality standard.

For us, quality means ensuring that each movement system always meets the same reliable standards, so that each individual system fulfils the high demands. That's why only one thing counts for our experienced teams when it comes to quality: To ensure that GRASS products continue setting the standard in future through their quality and excellence across the board when it comes to technology, design, reliability and longevity.



The packaging plant at the Götzis site uses two separately controlled robotic arms to process around 110 different packaging variants. With a cycle rate of just six seconds per slide set, the system's performance range ensures high efficiency – whether handling single boxes or outer packaging.



Exceptional products call for state-of-the-art production and testing facilities.

State-of-the-art machinery helps our highly qualified employees to create outstanding products. This includes state-of-the-art production lines, cutting-edge welding robots and automatic punching machines which, with a pressing force of several tonnes, can form the thickest sheet metal and feed the parts directly into the automatic assembly line without any further post-processing. Numerous testing and control stations integrated into the production lines use SPC (Statistical Process Control) to monitor consistent quality excellence, which forms the basis for a high level of customer satisfaction.

For us, development and production are seamlessly integrated. It is this belief that helps us transform ideas into new products.

Ideas can only become innovations if they can be produced in series at the highest level. Our engineers rely on all the benefits of modern development and production technology to manufacture these product ideas. Production and development departments work closely together across locations to guarantee the continuous optimisation of all production processes. After all, GRASS products are a promise that must be kept day after day.

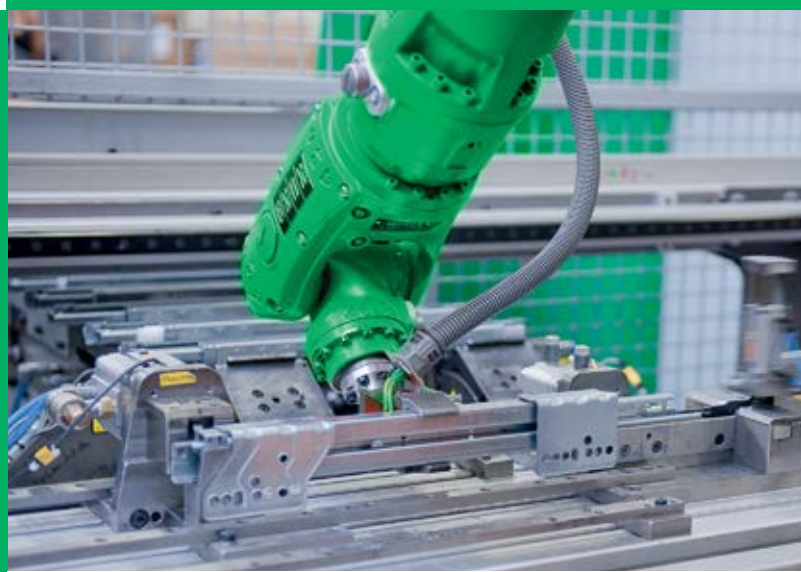

We produce tens of thousands of movement systems in our plants every day. To ensure that these systems meet our high quality management requirements, each product line is thoroughly tested on site. Our high internal standards, test procedures based on DIN and LGA and testing by independent institutes ensure systematic quality assurance.

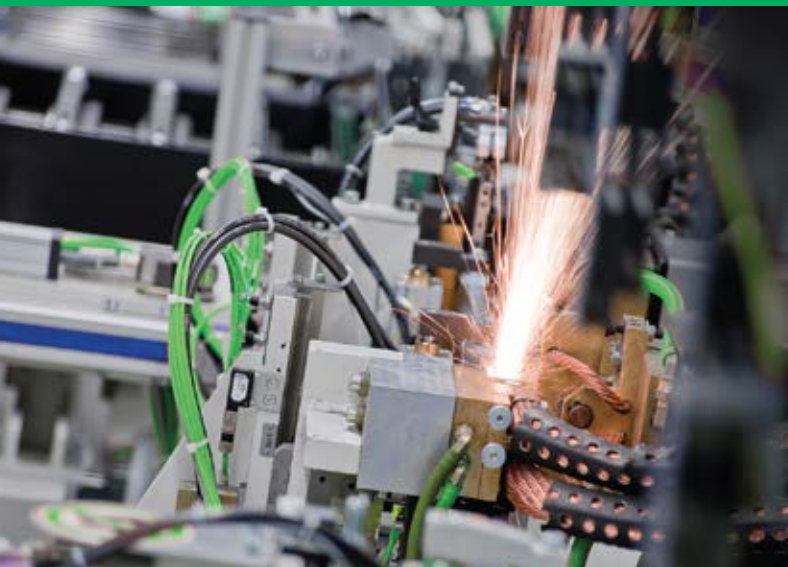

QUALITÄTS-ZERTIFIKAT
LGA



Photo: Rote Wand, Vorarlberg

Because we live and work in one of the most beautiful regions in the world, we share a responsibility to conserve natural resources.



Green power: In-house combined heat and power plant in Höchst.

With an output of 2000 kWh, the combined heat and power plant covers 75% of our electrical energy requirement. The waste heat can then be used to heat the premises or, in summer, to provide a substantial proportion of the cooling capacity via the absorption refrigerator.



GRASS drawer systems are almost 100% recyclable and do not contain any hazardous substances or substances specified in the REACH regulation*.

We see the present as part of the future.

Active involvement in environmental protection is an important prerequisite for long-term company success. Working with this mindset means conserving resources and creating ecologically sound production conditions. We have high expectations of ourselves, and our efforts to keep our ecological footprint as low as possible require a continuous improvement process that incorporates all areas of the company.

* Substances of very high concern on the candidate list for approval in the EU.

For GRASS, environmental protection is a fundamental corporate objective. Taking personal responsibility is part of our identity.



Since 2010, the GRASS Group's international environmental management system has been certified according to ISO 14001. GRASS's strong environmental commitment and dedicated projects dating back many years are entirely rooted in **our love of nature.**



**CO2 savings:
640 tonnes
per year.**

Extensive energy efficiency measures have significantly reduced our CO₂ emissions.



**Recycling of
steel waste.
6650 tonnes
per year.**

100% of steel waste generated during production is recycled.

**Heat requirements reduced
through heat
recovery.**

Compressor and exhaust gas heat exchange systems with a total output of over 3000 kW also improve our carbon footprint.



**Energy savings:
18% reduction
in power consumption.**

Reduction in overall electricity demand from 62 million kWh to 51 million kWh per year in the last 5 years.

**40% waste
reduction:
640 tonnes
per year.**

The volume of non-recyclable waste has been reduced from 1530 tonnes to 905 tonnes per year.



GRASS SOUTH AFRICA

This catalogue consists of some products not produced by GRASS, but distributed and supplied by GRASS South Africa.

For further information on GRASS products refer to our International catalogue - www.grass.eu

MOVEMENT SYSTEMS | FITTINGS & ACCESSORIES CATALOGUE 2023





VIONARO DRAWER SYSTEM	11
NOVA PRO SCALA DRAWER SYSTEM	12
NOVA PRO SCALA STORAGE SYSTEM	13
NOVA PRO SOLUTION SYSTEMS	14
DWD XP DRAWER SYSTEM	15
DYNAMOOV/DYNAPRO DRAWER SYSTEM	16
DYNAPRO BASE MOUNT DRAWER SYSTEM	17
INTEGRA DRAWER SYSTEM	18
KINVARO FLAP-UP/FLAP-DOWN SYSTEMS	19 - 21
TIOMOS HIDDEN HINGE	22
TIOMOS M SERIES HINGE	23
TIOMOS HINGE SOFT-CLOSE	24 - 25
NEXIS CLICK-ON HINGE	26 - 27
NEXIS SLIDE-ON HINGE	28 - 29
OMNI CLICK-ON HINGE SOFT-CLOSE	30 - 31
OMNI CLICK-ON/SLIDE-ON HINGE	32 - 33
OMNI TIPMATIC/SOFT-CLOSE ACTIVATOR	34
OMNI SLIDE SYSTEMS	35
ORGANISING SYSTEMS - TAVINEA SORTO/TAVINEA OPTIMA	36 - 39
CUTLERY INSERTS	40
RUBBER MATTING	41
HANDLE PROFILES	42 - 44
VCUBE AND VWALL	45 - 47
SLIDING DOOR SYSTEM	48 - 54
DISPLAY WINE SYSTEMS	55 - 60
SIGE LARDER PULL-OUT	61 - 62
SIGE PULL-OUT SHELF	63
SIGE ROTATION CORNER	64
SIGE PULL-OUT CORNER	65
SIGE PULL-OUT BASE 150 MM AND 300 MM	66 - 67
SIGE LAUNDRY BIN	68
ACCESSORIES FOR NOVA PRO SCALA DRAWERS	69
SIGE RECYCLE BINS	70 - 71
SIGE WASTE BINS	72
ITALIANA FERRAMENTA PUSH TO OPEN / LIBRA H11 / K-LINE	73 - 75
AMBOS WARDROBE LIFT	76
OMNI ACCESSORIES	77 - 80
OMNI KNOCK DOWN FITTINGS	81 - 82



DEPTH	HEIGHT					COLOUR
	63 MM	89 MM	121 MM	185 MM	249 MM	
270	-	■	-	-	-	GRAPHITE
350	-	■	■	■	-	GRAPHITE
400	-	■	■	■	-	GRAPHITE
450	■	■	■	■	■	GRAPHITE
500	■	■	■	■	■	GRAPHITE



DEPTH	HEIGHT					COLOUR
	63 MM	89 MM	121 MM	185 MM	249 MM	
270	-	■	-	-	-	WHITE
350	-	■	■	■	-	WHITE
400	-	■	■	■	-	WHITE
450	■	■	■	■	■	WHITE
500	■	■	■	■	■	WHITE



DEPTH	HEIGHT					COLOUR
	63 MM	89 MM	121 MM	185 MM	249 MM	
400	-	■	-	-	-	SILVER
450	-	■	-	■	-	SILVER
500	-	■	-	■	-	SILVER

FEATURES: Slim 13 mm drawer side
4D Adjustment
90° straight interior and exterior sides

Tool free front assembly
Available in 3 colours
Available in 5 heights

Available in 40 kg and 70 kg
Fully synchronized slides
Can use same dynapro runner for wooden box and metal sides





DEPTH	HEIGHT						COLOUR
	63 MM	90 MM	122 MM	140 MM	186 MM	250 MM	
270	-	■	-	-	-		STONE
300	-	■	-	-	■		STONE
350	-	■	-	-	■		STONE
400	■	■	-	-	■		STONE
450	■	■	■	-	■		STONE
500	■	■	■	■	■	■	STONE
550	-	■	■		■	■	STONE



DEPTH	HEIGHT						COLOUR
	63 MM	90 MM	122 MM	140 MM	186 MM	250 MM	
270	-	■	-	-	-		ICE
300	-	■	-	-	■		ICE
350	-	■	-	-	■		ICE
400	■	■	-	-	■		ICE
450	■	■	■	-	■		ICE
500	■	■	■	■	■	■	ICE
550	-	■	■		■	■	ICE



DEPTH	HEIGHT					COLOUR
	63 MM	90 MM	122 MM	140 MM	186 MM	
270	-	■	-	-	-	SILVER
350	-	■	-	-	-	SILVER
400	-	■	-	-	-	SILVER
450	-	■	-	-	-	SILVER
500	-	■	-	■	■	SILVER

FEATURES: Double wall drawer
Can be personalised with designer panels
Integrated height and side adjustment
Robust design and high level of stability

Optimum use of space due to straight inside surfaces and low construction width
Tool free installation and removal of drawer front
Width of bottom and back panel is the same

Available in 40 kg & 70 kg
Fully synchronised slides
Compatible with Tavinea Sorto



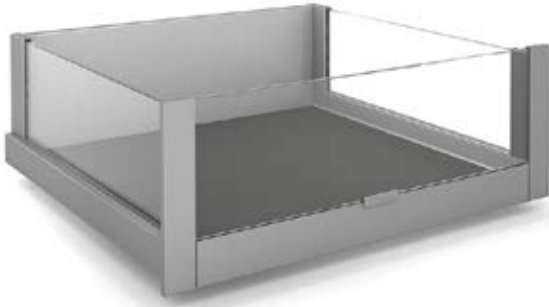

DESCRIPTION	CODE	COLOUR	PACK SIZE
INSET PANEL 8MM CRYSTAL BRACKET	F102132468211	STONE	SET
INSET PANEL 8MM CRYSTAL BRACKET	F102132469211	WHITE	SET
INSET PANEL 8MM CRYSTAL BRACKET	F102132470211	SILVER	SET
ACC FOR INSET PANEL	F102132471511	STONE	SET
ACC FOR INSET PANEL	F102132472511	WHITE	SET
ACC FOR INSET PANEL	F102132473511	SILVER	SET

FEATURES: Elegant design
 Low complexity of parts
 Easy to install
 Slide in front element is 6mm
 Slide in side element is 8mm
 Can be used with H186 and Crystal Plus drawer sides

PLANNING DIMENSIONS

All dimensions in millimetres

Installation dimensions	Front panel profile H186	High glass												
		Low glass												
		Cutting dimensions for cross profile												
	<table border="1"> <thead> <tr> <th colspan="3">Slide</th> </tr> <tr> <th>S</th> <th>16 / 19</th> <th>18</th> </tr> <tr> <th>EB</th> <th>29</th> <th>30</th> </tr> </thead> <tbody> <tr> <td colspan="3"> Note: Slide available in two versions: S16/S19 and S18. See the chapter on slides (from page 320 onwards). </td> </tr> </tbody> </table>	Slide			S	16 / 19	18	EB	29	30	Note: Slide available in two versions: S16/S19 and S18. See the chapter on slides (from page 320 onwards).			
Slide														
S	16 / 19	18												
EB	29	30												
Note: Slide available in two versions: S16/S19 and S18. See the chapter on slides (from page 320 onwards).														

* Recommendation/minimum dimension: 49.5 mm/Tipmatic Soft-close: 58 mm



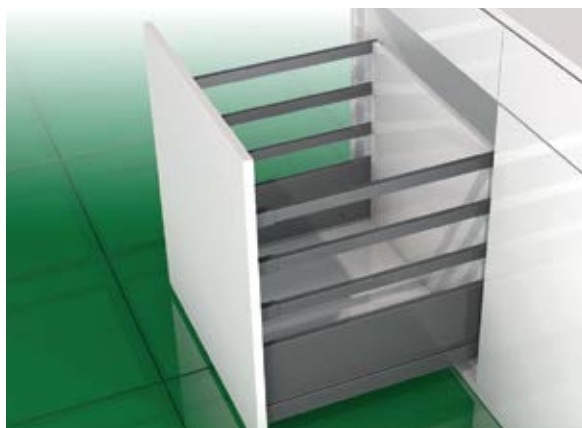

DESCRIPTION	SIZE	FINISH
NOVA PRO SCALA LAUNDRY DRAWER	450 MM - 600 MM	STONE / WHITE / SILVER

FEATURES: Up to 600 MM wide
Large high front
High drawer side of 250 MM
Tilt angle adjustment by means of railing
Suitable for all large container options eg. Dog food storage



DESCRIPTION	SIZE	FINISH
NOVA PRO SCALA CUSTOM SPICE PULLOUT	150 MM - 400 MM	STONE / WHITE / SILVER

FEATURES: Spice and bottle pullout in custom widths
From 150 MM - 400 MM widths
2 or 3 tiers
Use with 63 MM, 90 MM, 122 MM and 186 MM drawer side heights
80 KG or 120 KG weight capacities



DESCRIPTION	SIZE	FINISH
NOVA PRO SCALA RECYCLING BIN 450 MM	450 MM	STONE / WHITE / SILVER

FEATURES: Large high front
Cost effective bin system
Use with 90 MM 122 MM or 185MM drawer side heights
Tilt angle adjustment by means of railing
Litre capacity 35 L x 2



DESCRIPTION	SIZE	FINISH
NOVA PRO SCALA RECYCLING BIN 500 MM	500 MM	STONE / WHITE / SILVER

FEATURES: Large high front
Cost effective bin system
Use with 250 MM high drawer side heights
Tilt angle adjustment by means of drawer side
Litre capacity 35 L x 2



DRAWER TYPE	DRAWER LENGTH NL	COLOUR
DWD XP H95	275	GREY
	400	GREY
	450	GREY
	500	GREY
RAILSET ROUND	400	GREY
	450	GREY
	500	GREY
RAILSET SQUARE	450	GREY
	500	GREY



DRAWER TYPE	DRAWER LENGTH NL	COLOUR
DWD XP H95	275	WHITE
	400	WHITE
	450	WHITE
	500	WHITE
RAILSET SQUARE	400	WHITE
	450	WHITE
	500	WHITE



DRAWER TYPE	DRAWER LENGTH NL	COLOUR
DWD XP H95	400	STONE
	450	STONE
	500	STONE
RAILSET SQUARE	400	STONE
	450	STONE
	500	STONE

FEATURES: Double wall drawer
40 kg + 60 kg
2D Adjustment

Fully synchronised
Full extension
Width of bottom and back panel is the same

Compatible with Tavinea Sorto





DRAWER TYPE	DRAWER LENGTH NL	CODE	ADD + 1D LOCKING DEVICE
DYNAMOOV SOFT-CLOSE 30 KG	270	F130107761211	F134101220
	300	F130107764211	F134101220
	350	F130107768211	F134101220
	400	F130107772211	F134101220
	450	F130107776210	F134101220
	500	F130107780210	F134101220
	550	F130107784210	F134101220

DRAWER TYPE	DRAWER LENGTH NL	CODE	ADD + D LOCKING DEVICE
DYNAMOOV TIPMATIC 30 KG	300	F130101115211	F134101220
	350	F130101117211	F134101220
	400	F130101119211	F134101220
	450	F130101121210	F134101220
	500	F130101123210	F134101220
	550	F130101125210	F134101220



DRAWER TYPE	DRAWER LENGTH NL	CODE	ADD + 2D LOCKING DEVICE
DYNAPRO SOFT-CLOSE 40 KG	300	F130107796204	F134117193
	350	F130107802204	F134117193
	400	F130107808204	F134117193
	450	F130107814204	F134117193
	500	F130107820204	F134117193
	550	F130107826204	F134117193
DYNAPRO SOFT-CLOSE 70 KG	500	F130107838204	F134117193
TIPMATIC SOFT-CLOSE ADD-ON	SYNC ROD	F134109410207	
	ACTIVATOR	F134109323607	

FEATURES: Undermount slide 30 kg, 40 kg and 70 kg options 2D, 3D and 4D Adjustment options Fully synchronised Full extension Minimum drawer deflection Dynapro can be used with vionaro steel sides



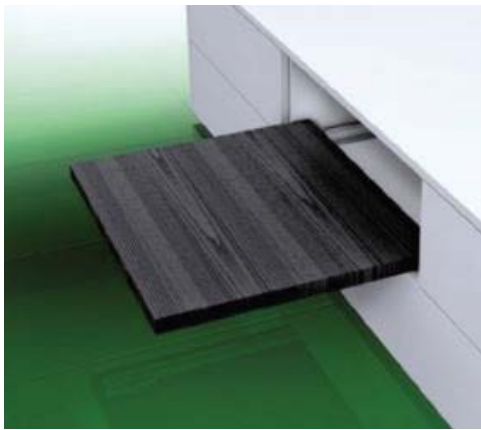

DRAWER LENGTH	CODE	ADD SHELF CLIP SET
BASE MOUNT FULL EXTENSION 450 MM	F130107884210	F134107411517
BASE MOUNT FULL EXTENSION 500 MM	F130107890210	F134107411517
BASE MOUNT FULL EXTENSION 550 MM	F130107893604	F134107411517

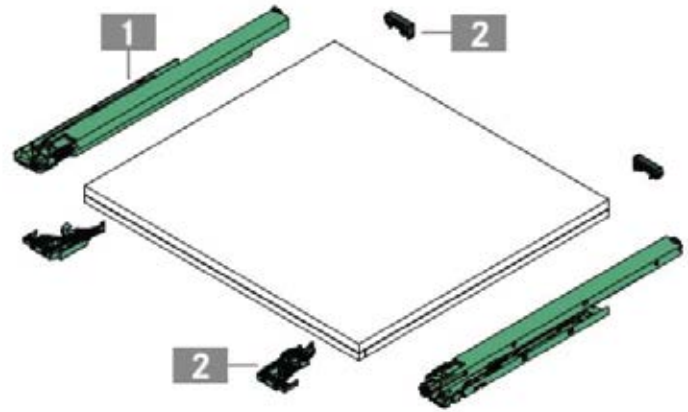

FEATURES:

Undermount base mount slide
Full extension 40 kg load capacity
Soft-close

Assembly on cabinet base
Height adjustment + 3.5 m



53 MM DRAWER



DRAWER TYPE	DRAWER LENGTH NL	CODE	ADD	ADD	AD D
			LEFT BRACKET	RIGHT BRACKET	COVER CAP
INTEGRA H-53	450	F084074926207	F084115209236	F084115210236	-
	500	F084074917207	F084115209236	F084115210236	-

85 MM DRAWER



DRAWER TYPE	DRAWER LENGTH NL	CODE	ADD	ADD	AD D
			LEFT BRACKET	RIGHT BRACKET	COVER CAP X2
INTEGRA H-85	275	F084074972207	F084115231236	F084115233236	F084075011240
	350	F084074952207	F084115231236	F084115233236	F084075011240
	400	F084074959207	F084115231236	F084115233236	F084075011240
	450	F084074960207	F084115231236	F084115233236	F084075011240
	500	F084074961207	F084115231236	F084115233236	F084075011240
	550	F084074968207	F084115231236	F084115233236	F084075011240

149 MM DRAWER



DRAWER TYPE	DRAWER LENGTH NL	CODE	ADD	ADD	AD D
			LEFT BRACKET	RIGHT BRACKET	COVER CAP X2
INTEGRA H-149	450	F084075168204	F084115231236	F084115233236	F084075011240
	500	F084075170204	F084115231236	F084115233236	F084075011240

RAIL SETS

TYPE	SIZE	CODE
INTEGRA POT RAIL SET	500	3500.500.2
INTEGRA FILING RAIL	500	F084074850511



FEATURES: Single wall drawer
30 kg
2D Adjustments





FLAP TYPE	MIN HEIGHT	MAX HEIGHT	RANGE OF FLAP	CODE
KINVARO T-65	200	300	Width: Up to 1200 mm	F151147797201
KINVARO T-70	300	400	Width: Up to 1200 mm	F151147693201
KINVARO T-75	400	600	Width: Up to 1200 mm	F151147700201



FLAP TYPE	MIN HEIGHT	MAX HEIGHT	RANGE OF FLAP	CODE
KINVARO F-20	600	900	Width: 450 mm-1200 mm	
TYPE 4B	600	649	Weight: 4.1 kg - 12.1kg	F152147675201
TYPE 4C	600	649	Weight: 6.8 kg - 15.8 kg	F152147842201
TYPE 5B	650	699	Weight: 3.8 kg - 11.4 kg	F152147840201
TYPE 6C	700	749	Weight: 6.5 kg - 16.4 kg	F152147844201
TYPE 6D	700	749	Weight: 10.0 kg - 18.0 kg	F152147846201
TYPE 7C	750	799	Weight: 6.0 kg - 15.6 kg	F152147787201
TYPE 7D	750	900	Weight: 6.5 kg - 16.5 kg	F152147847201



FLAP TYPE	MIN HEIGHT	MAX HEIGHT	RANGE OF FLAP	CODE
KINVARO L-80	350	600	Width: 450 mm-1200 mm	
TYPE 5B	430	600	Weight: 4.0 kg - 7.5 kg	F152147715201

HOW TO CALCULATE YOUR DOOR WEIGHT:

FLAP WIDTH X FLAP HEIGHT X FLAP THICKNESS X DENSITY + HANDLE = WEIGHT OF FLAP

DENSITIES: MDF 0.85KG, CHIPBOARD 0.65KG, PINE 0.45KG

FOR BAR HANDLES, ALLOW 0.1KG FOR EACH 100 MM HANDLE WIDTH

LIFTS COME WITH ADJUSTABLE DAMPING/ SOFT-CLOSE SYSTEM

WE RECOMMEND A TRIAL FIT BEFORE FINAL INSTALLATION

ALL KINVARO F-20 MODELS NEED NEXIS 125 DEG HINGES IN ORDER TO OPEN IN A MAXIMUM POSITION.





FLAP TYPE	DESCRIPTION	POWER FACTOR	CODE
T - SLIM FLAP	SOFT CLOSE - STONE	500 - 1100	F151149005201
T - SLIM FLAP	SOFT CLOSE - STONE	1000 - 2250	F151149008201
T - SLIM FLAP	TIPMATIC - STONE	500 - 1100	F151149014201
T - SLIM FLAP	TIPMATIC - STONE	1000 - 2250	F151149017201
T - SLIM ADAPTER	ADAPTER - STONE	-	F161149020204



FEATURES:

Inset flush fit on carcass side
Or surface mounted on carcass side (adapter needed)
Milling depth carcass side 12.2 mm
Milling depth door 13.7 mm

3D adjustment
All cover caps paintable
Available in soft close or auto opening (Tipmatic)
Available for wooden doors only in SA





FLAP TYPE	MIN HEIGHT	MAX HEIGHT	MAX WEIGHT	CODE
KINVARO D-S WHITE 40N	200	480	3 KG	F053139664607
KINVARO D-S NIGHT 40N	200	480	3 KG	F053139665607
KINVARO D-S WHITE 60N	200	480	6 KG	F053139666607
KINVARO D-S NIGHT 60N	200	480	6 KG	F053139667607
KINVARO D-M WHITE 100N	200	480	10 KG	F053139662607 WH
KINVARO D-M NIGHT 100N	200	480	10 KG	F053139662607 N
KINVARO D-M WHITE 200N	200	480	12 KG	F053139687607 WH
KINVARO D-M NIGHT 200N	200	480	12 KG	F053139687607 N



DESCRIPTION	APPLICATION	CODE	PACK SIZE
TIOMOS FLAP HINGE NICKEL	OVERLAY 90°	F053139671	EACH
TIOMOS FLAP HINGE NIGHT	OVERLAY 90°	F053139677	EACH
TIOMOS FLAP HINGE ADAPTER NICKEL	-	F053139676236	EACH
TIOMOS FLAP HINGE ADAPTER NIGHT	-	F053139684236	EACH

DRILLING PATTERNS

Front

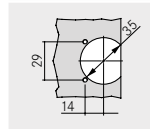

Cabinet

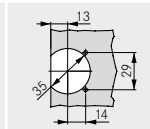

CUP DIMENSIONS

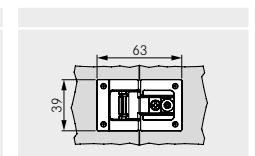
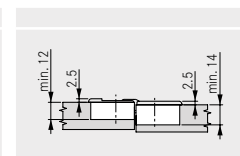

FEATURES:

- Modern design
- 90° opening angle
- For flap thicknesses of up to 21 mm
- Narrow gaps between door and cabinet
- Large overlay of up to 19 mm
- 12 mm cup depth
- 3 Dimensional adjustment
- Very suitable for combining with the Kinvaro D flap stays





DESCRIPTION	APPLICATION	CODE	PACK SIZE
TIOMOS HIDDEN HINGE NICKEL	OVERLAY 105°	F051139126507	PAIR
TIOMOS HIDDEN HINGE NIGHT	OVERLAY 105°	F051139125507	PAIR

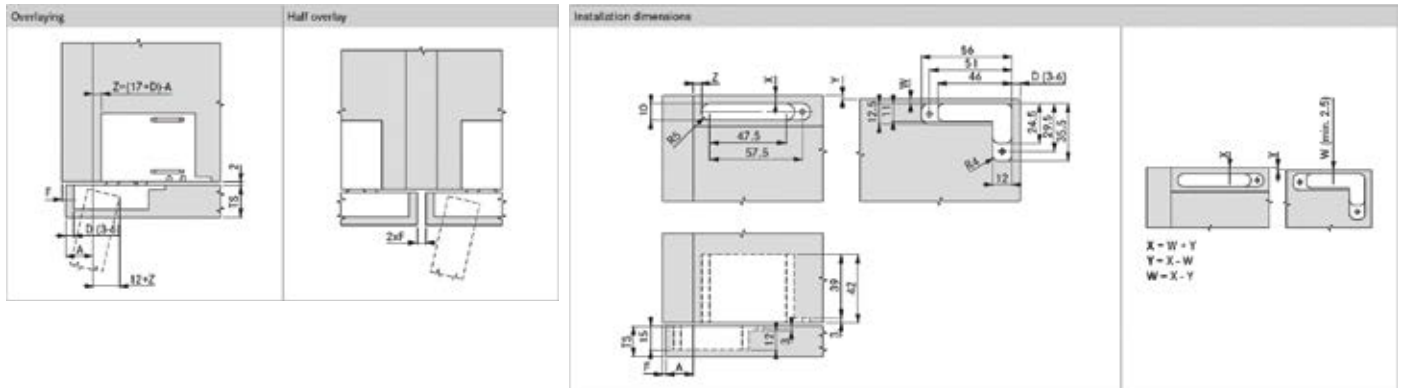

FEATURES: Perfectly concealed hinge
 Opening angle 105°
 Integrated Soft-close damper

3 Dimensional adjustment
 For door thicknesses from 18 mm
 Door rebate depth: 15 mm

Cabinet rebate depth: 42 mm
 Surface: nickel-plated, night
 Loadbearing capacity up to 18 kg





DESCRIPTION	APPLICATION	CODE	PACK SIZE
TIOMOS MIRROR/CLEAR GLASS HINGE 125°	MIRROR OR CLEAR GLASS	F029140325	EACH
TIOMOS MIRROR/CLEAR GLASS HINGE NIGHT	MIRROR OR CLEAR GLASS	F029140468	EACH
ECO CROSS 0 MM M/PLATE	-	F058139721217	EACH
ZAMAK ADAPTER FOR CLEAR GLASS	CLEAR GLASS	F072135868	EACH

FEATURES: 125° opening angle
 Fastening through door-side gluing of Zamak adapter
 Connection of the hinge to the adapter using a cam

Quick final assembly without glass drilling
 High overlay up to 19 mm



DESCRIPTION	APPLICATION	CODE	PACK SIZE
TIOMOS M9 HINGE 110°	DOOR THICKNESS FROM 12-28 MM	F029140334	EACH
ECO CROSS 0 MM M/PLATE	-	F058139721217	EACH

FEATURES: For door thicknesses up to max. 28 mm
 35 mm full cup drilled hole
 Low cup depth of 9 mm
 For mitred door applications

For rebate door applications
 3-dimensional adjustment with appropriate mounting plate
 For door overlays up to 25 mm



DESCRIPTION	APPLICATION	CODE	PACK SIZE
TIOMOS M0 HINGE 125°	DOOR THICKNESS 6-10 MM	F029140331217	EACH
ECO CROSS 0 MM M/PLATE	-	F058139721217	EACH

FEATURES: For door thicknesses for 6 - 10 mm
 No cup hole necessary
 3-dimensional adjustment
 For door overlays of up to 25 mm

Compatible with all mounting plates
 Zero protrusion up to 14 mm overlay
 125° opening angle



DESCRIPTION	APPLICATION	CODE	PACK SIZE
TIOMOS REFRIGERATOR HINGE 100°	FRIDGE APPLICATION	F045139052228	EACH
ECO CROSS 0MM M/PLATE	-	F058139721217	EACH

FEATURES: Flat hinge arm
 No soft-close

Hinge for fridge doors (sliding system)
 3-dimensional adjustment





DESCRIPTION	APPLICATION	CODE	PACK SIZE
TIOMOS HINGE DOWEL SOFT-CLOSE	OVERLAY 110°	F028138098228	150
TIOMOS HINGE DOWEL SOFT-CLOSE	HALF OVERLAY 110°	F028138099228	150
TIOMOS HINGE DOWEL SOFT-CLOSE	INSET OVERLAY 110°	F028138100217	150

FEATURES: Door thickness up to 24 mm
 Dept adjustment via worm gear
 3D Adjustment with appropriate mounting plates

Adjustable soft-close
 12.6 mm Cup depth



DESCRIPTION	APPLICATION	CODE	PACK SIZE
TIOMOS HINGE DOWEL SOFT-CLOSE	INSET 110/45° CORNER	F028138118223	50

FEATURES: For 45° angled cabinets
 110° Opening angle
 3D Adjustment



DESCRIPTION	APPLICATION	CODE	PACK SIZE
TIOMOS HINGE DOWEL SOFT-CLOSE	INSET 90 MM POST HINGE	F028138120213	50

FEATURES: For blind corner applications
 110° Opening angle
 3D Adjustment



DESCRIPTION	APPLICATION	CODE	PACK SIZE
TIOMOS HINGE DOWEL SOFT-CLOSE	OVERLAY 155° MBP	F028138139217	50
TIOMOS HINGE DOWEL SOFT-CLOSE	HALF OVERLAY 155° MBP	F028138140213	50

FEATURES: 160° Opening angle
 Zero protrusion
 Shallow cup depth of 10 mm

Door thickness up to 32 mm
 3D Adjustment



DESCRIPTION	APPLICATION	CODE	PACK SIZE
TIOMOS HINGE DOWEL NON SOFT-CLOSE	PIE-CUT/BI-FOLD	F045138092	50

FEATURES: For connecting 2 cabinet doors
 Shallow cup depth 11.8 mm
 3D Adjustment

24 mm Max door thickness
 No soft-close



DESCRIPTION	APPLICATION	CODE	PACK SIZE
TIOMOS HINGE NIGHT B.BP	OVERLAY 110° NIGHT	F028139129228	EACH
TIOMOS HINGE IMPRESSO NIGHT	OVERLAY 110° NIGHT	F017140378228	EACH
TIOMOS HINGE ALU NIGHT	OVERLAY 110° 20/20 NIGHT	F028140404228	EACH
TIOMOS HINGE SCREW FIX NIGHT	OVERLAY 155° NIGHT	F028140944217	EACH
TIOMOS HINGE SCREW FIX NIGHT	BLIND CORNER NIGHT	F028140961223	EACH
TIOMOS MOUNTING PLATE NIGHT	1D LINEAR SCREW FIX 3 MM NIGHT	F059139979228	EACH
TIOMOS HINGE ARM COVER NIGHT	ARM COVER NIGHT	F072140519228	EACH
TIOMOS HINGE CUP COVER NIGHT	CUP COVER NIGHT	F072140520228	EACH



DESCRIPTION	APPLICATION	CODE	PACK SIZE
TIOMOS MOUNTING PLATE	ECO CROSS SCREW FIX - 2 MM	F058139720228	150
TIOMOS MOUNTING PLATE	ECO CROSS SCREW FIX 0 MM	F058139721217	150
TIOMOS MOUNTING PLATE	ECO CROSS SCREW FIX 3 MM	F058139723228	150
TIOMOS MOUNTING PLATE	ECO CROSS MOUNTED EURO FIX - 2 MM	F058139735228	150
TIOMOS MOUNTING PLATE	ECO CROSS MOUNTED EURO FIX 0 MM	F058139736228	150
TIOMOS MOUNTING PLATE	ECO CROSS MOUNTED EURO FIX 3 MM	F058139738228	150



DESCRIPTION	APPLICATION	CODE	PACK SIZE
TIOMOS MOUNTING PLATE	1D SCREW FIX 0 MM	F058139746217	150
TIOMOS MOUNTING PLATE	1D SCREW FIX 3 MM	F058139748217	150
TIOMOS MOUNTING PLATE	1D SCREW FIX 6 MM	F058139892217	150
TIOMOS MOUNTING PLATE	1D MOUNTED EURO SCREW 3 MM	F058139763217	150
TIOMOS MOUNTING PLATE	1D MOUNTED EURO SCREW 6 MM	F058139873217	150



DESCRIPTION	APPLICATION	CODE	PACK SIZE
TIOMOS MOUNTING PLATE	1D LINEAR SCREW FIX 0 MM	F058139701217	150
TIOMOS MOUNTING PLATE	1D LINEAR SCREW FIX 3 MM	F058139703217	150
TIOMOS MOUNTING PLATE	1D LINEAR DOWEL FIX 3 MM	F058139708228	150
TIOMOS MOUNTING PLATE	1D LINEAR EURO FIX 3 MM	F058139713228	150

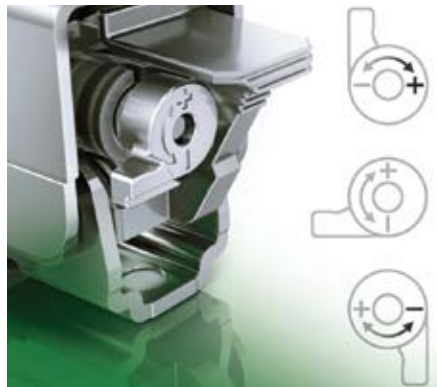



DESCRIPTION	APPLICATION	CODE	PACK SIZE
NEXIS HINGE CLICK-ON SCREW-IN	FULL OVERLAY 100°	F015072722236	250
NEXIS HINGE CLICK-ON DOWEL	FULL OVERLAY 100°	F015072719236	250

FEATURES: Door thickness up to 24 mm
 Cup depth 11 mm
 Clip on with various plate options
 Soft-close compatible
 3 Dimensional adjustment with appropriate plate



DESCRIPTION	APPLICATION	CODE	PACK SIZE
NEXIS HINGE CLICK-ON SCREW-IN	HALF OVERLAY 100°	F015072729236	250
NEXIS HINGE CLICK-ON DOWEL	HALF OVERLAY 100°	F015072727236	250

FEATURES: Door thickness up to 24 mm
 Cup depth 11 mm
 Clip on with various plate options
 Soft-close compatible
 3 Dimensional adjustment with appropriate plate



DESCRIPTION	APPLICATION	CODE	PACK SIZE
NEXIS HINGE CLICK-ON SCREW-IN	INSET 100°	F015072736236	250
NEXIS HINGE CLICK-ON DOWEL	INSET 100°	F015072732236	250

FEATURES: Door thickness up to 24 mm
 Cup depth 11 mm
 Clip on with various plate options
 Soft-close compatible
 3 Dimensional adjustment with appropriate plate



DESCRIPTION	APPLICATION	CODE	PACK SIZE
NEXIS HINGE CLICK-ON SCREW-IN	INSET 45° CORNER	F015072751225	125
NEXIS HINGE CLICK-ON DOWEL	INSET 45° CORNER	F015072750225	125

FEATURES: Door thickness up to 30 mm
 Cup depth 11.8 mm
 Clip on with various plate options
 Soft-close compatible
 3 Dimensional adjustment with appropriate plate
 95° Opening angle



DESCRIPTION	APPLICATION	CODE	PACK SIZE
NEXIS HINGE CLICK-ON SCREW-IN	INSET 83 MM POST/BLIND CORNER	F015072788225	125
NEXIS HINGE CLICK-ON DOWEL	INSET 83 MM POST/BLIND CORNER	F015072787225	125

FEATURES: Door thickness up to 30 mm
 Cup depth 11.8 mm
 Clip on with various plate options
 Soft-close compatible
 3 Dimensional adjustment with appropriate plate
 95° Opening angle



DESCRIPTION	APPLICATION	CODE	PACK SIZE
NEXIS HINGE CLICK-ON SCREW-IN	FULL OVERLAY 170°	F015072842217	50
NEXIS HINGE CLICK-ON DOWEL	FULL OVERLAY 170°	F015072840217	50

FEATURES: Door thickness up to 26 mm
 Cup depth 11 mm
 Clip on with various plate options
 Soft-close compatible
 3 Dimensional adjustment with appropriate plate
 Zero protusion hinge at 90° opening angle



DESCRIPTION	APPLICATION	CODE	PACK SIZE
NEXIS CLICK-ON CROSS M/PLATE	SCREW FIX 2 MM	F060073145236	250



DESCRIPTION	APPLICATION	CODE	PACK SIZE
NEXIS CLICK-ON CROSS M/PLATE	MOUNTED EURO SCREW 2 MM	F060073180236	250



DESCRIPTION	APPLICATION	CODE	PACK SIZE
NEXIS HINGE STANDARD	SOFT-CLOSE ADAPTER	F069073715225	125
NEXIS HINGE 170 DEG	SOFT-CLOSE ADAPTER	F069073729225	125



DESCRIPTION	CODE	SIZE	FINISH
KPUSH TECH WITH BUFFER STRONG	57008080AB	70 MM	WHITE
MOUNTING PLATE WITH HOUSING	57010040	80 MM	WHITE
KPUSH TECH WITH BUFFER STRONG	57008080EE	70 MM	GRAPHITE
MOUNTING PLATE WITH HOUSING	57010040G	80 MM	GRAPHITE



DESCRIPTION	APPLICATION	CODE	PACK SIZE
NEXIS HINGE SLIDE-ON SCREW-IN	FULL OVERLAY 100°	F016073008236	250
NEXIS HINGE SLIDE-ON DOWEL	FULL OVERLAY 100°	F016073010236	250

FEATURES: Door thickness up to 24 mm
Cup depth 11 mm
Slide on with various plate options
Soft-close compatible
3 Dimensional adjustment with appropriate plate



DESCRIPTION	APPLICATION	CODE	PACK SIZE
NEXIS HINGE SLIDE-ON SCREW-IN	HALF OVERLAY 100°	F016073014236	250
NEXIS HINGE SLIDE-ON DOWEL	HALF OVERLAY 100°	F016073016236	250

FEATURES: Door thickness up to 24 mm
Cup depth 11 mm
Slide on with various plate options
Soft-close compatible
3 Dimensional adjustment with appropriate plate



DESCRIPTION	APPLICATION	CODE	PACK SIZE
NEXIS HINGE SLIDE-ON SCREW-IN	INSET 100°	F016073018236	250
NEXIS HINGE SLIDE-ON DOWEL	INSET 100°	F016073020236	250

FEATURES: Door thickness up to 24 mm
Cup depth 11 mm
Slide on with various plate options
Soft-close compatible
3 Dimensional adjustment with appropriate plate



DESCRIPTION	APPLICATION	CODE	PACK SIZE
NEXIS HINGE SLIDE-ON SCREW-IN	INSET 45° CORNER	F016073033225	125

FEATURES: Door thickness up to 30 mm
Cup depth 11.8 mm
Slide on with various plate options
Soft-close compatible
3 Dimensional adjustment with appropriate plate
95° Opening Angle



DESCRIPTION	APPLICATION	CODE	PACK SIZE
NEXIS HINGE SLIDE-ON SCREW-IN	63 MM INSET/BLIND-CORNER	F016073048225	125

FEATURES: Door thickness up to 30 mm
Cup depth 11.8 mm
Slide on with various plate options
Soft-close compatible
3 Dimensional adjustment with appropriate plate
95° Opening Angle



DESCRIPTION	APPLICATION	CODE	PACK SIZE
NEXIS HINGE SLIDE-ON SCREW-IN	FULL OVERLAY 170°	F016073077217	50
NEXIS HINGE SLIDE-ON DOWEL	FULL OVERLAY 170°	F016073078217	50

FEATURES: Door thickness up to 26 mm
 Cup depth 11 mm
 Slide on with various plate options
 Soft-close compatible
 3 Dimensional adjustment with appropriate plate
 Zero protrusion hinge at 90° opening



DESCRIPTION	APPLICATION	CODE	PACK SIZE
NEXIS SLIDE-ON M/PLATE	SCREW FIX - 0 MM	F062073298236	250



DESCRIPTION	APPLICATION	CODE	PACK SIZE
NEXIS SLIDE-ON M/PLATE	MOUNTED EURO SCREW - 0 MM	F062073316236	250



DESCRIPTION	APPLICATION	CODE	PACK SIZE
NEXIS HINGE STANDARD	SOFT-CLOSE ADAPTER	F069073715225	125
NEXIS HINGE 170 DEG	SOFT-CLOSE ADAPTER	F069073729225	125



DESCRIPTION	CODE	SIZE	FINISH
KPUSH TECH WITH BUFFER STRONG	57008080AB	70 MM	WHITE
MOUNTING PLATE WITH HOUSING	57010040	80 MM	WHITE
KPUSH TECH WITH BUFFER STRONG	57008080EE	70 MM	GRAPHITE
MOUNTING PLATE WITH HOUSING	57010040G	80 MM	GRAPHITE



DESCRIPTION	APPLICATION	CODE	PACK SIZE
OMNI HINGE CLICK-ON SCREW-IN	FULL OVERLAY SOFT-CLOSE 110°	A36A07	200
OMNI HINGE CLICK-ON DOWEL	FULL OVERLAY SOFT-CLOSE 110°	A36A07N	200

FEATURES: Door thickness up to 16 mm
Cup depth 11.3 mm
Clip on with various plate options



DESCRIPTION	APPLICATION	CODE	PACK SIZE
OMNI HINGE CLICK-ON SCREW-IN	HALF OVERLAY SOFT-CLOSE 110°	A36A03	200
OMNI HINGE CLICK-ON DOWEL	HALF OVERLAY SOFT-CLOSE 110°	A36A03N	200

FEATURES: Door thickness up to 16 mm
Cup depth 11.3 mm
Clip on with various plate options



DESCRIPTION	APPLICATION	CODE	PACK SIZE
OMNI HINGE CLICK-ON SCREW-IN	INSET SOFT-CLOSE 110°	A36A01	200
OMNI HINGE CLICK-ON DOWEL	INSET SOFT-CLOSE 110°	A36A01N	200

FEATURES: Door thickness up to 16 mm
Cup depth 11.3 mm
Clip on with various plate options



DESCRIPTION	APPLICATION	CODE	PACK SIZE
OMNI HINGE CLICK-ON SCREW-IN	INSET SOFT-CLOSE 45°	AC12T02	100
OMNI HINGE CLICK-ON DOWEL	INSET SOFT-CLOSE 45°	AC12T02N	100

FEATURES: Door thickness up to 16 mm
Cup depth 11.3 mm
Clip on with various plate options



DESCRIPTION	APPLICATION	CODE	PACK SIZE
OMNI HINGE CLICK-ON SCREW-IN	INSET POST HINGE SOFT-CLOSE 110°	A1203	100
OMNI HINGE CLICK-ON DOWEL	INSET POST HINGE SOFT-CLOSE 110°	A1203N	100

FEATURES: Door thickness up to 16 mm
Cup depth 11.3 mm
Clip on with various plate options



DESCRIPTION	APPLICATION	CODE	PACK SIZE
OMNI HINGE CLICK-ON SCREW-IN	FULL OVERLAY SOFT-CLOSE 165°	AC2016	100
OMNI HINGE CLICK-ON DOWEL	FULL OVERLAY SOFT-CLOSE 165°	AC2016N	100

FEATURES: Door thickness up to 16 mm
 Cup depth 11.3 mm
 Clip on with various plate options



DESCRIPTION	APPLICATION	CODE	PACK SIZE
OMNI M/PLATE CLICK-ON	SCREW FIX - 0 MM	C31HO-4HOLE	500



DESCRIPTION	APPLICATION	CODE	PACK SIZE
OMNI M/PLATE CLICK-ON	10 MM MOUNTED EURO SCREW - 0 MM	C31H0D-10	500



DESCRIPTION	APPLICATION	CODE	PACK SIZE
OMNI M/PLATE CLICK-ON	13 MM MOUNTED EURO SCREW - 0 MM	C31H0D-13	500



DESCRIPTION	APPLICATION	CODE	PACK SIZE
OMNI M/PLATE CLICK-ON	SCREW FIX - ID	C31CAMHO	500



DESCRIPTION	APPLICATION	CODE	PACK SIZE
OMNI HINGE CLICK-ON SCREW IN	FULL OVERLAY 110°	C0406	250
OMNI HINGE CLICK-ON DOWEL	FULL OVERLAY 110°	C0406N	250

FEATURES: Door thickness up to 16 mm
Cup depth 11.3 mm
Clip on with various plate options



DESCRIPTION	APPLICATION	CODE	PACK SIZE
OMNI HINGE CLICK-ON SCREW IN	HALF OVERLAY 110°	C0403	250
OMNI HINGE CLICK-ON DOWEL	HALF OVERLAY 110°	C0403N	250

FEATURES: Door thickness up to 16 mm
Cup depth 11.3 mm
Clip on with various plate options



DESCRIPTION	APPLICATION	CODE	PACK SIZE
OMNI HINGE CLICK-ON SCREW IN	INSET 110°	C0401	250
OMNI HINGE CLICK-ON DOWEL	INSET 110°	C0401N	250

FEATURES: Door thickness up to 16 mm
Cup depth 11.3 mm
Clip on with various plate options



DESCRIPTION	APPLICATION	CODE	PACK SIZE
OMNI HINGE CLICK-ON SCREW IN	INSET 45° CORNER	C12T02	100
OMNI HINGE CLICK-ON DOWEL	INSET 45° CORNER	C12T02N	100

FEATURES: Door thickness up to 16 mm
Cup depth 11.3 mm
Clip on with various plate options



DESCRIPTION	APPLICATION	CODE	PACK SIZE
OMNI HINGE CLICK-ON SCREW IN	INSET/BLIND CORNER HINGE	C12T03	100
OMNI HINGE CLICK-ON DOWEL	INSET/BLIND CORNER HINGE	C12T03N	100

FEATURES: Door thickness up to 16 mm
Cup depth 11.3 mm
Clip on with various plate options



DESCRIPTION	APPLICATION	CODE	PACK SIZE
OMNI HINGE CLICK-ON SCREW IN	BI-FOLD/PIE-CUT FULL HOLE	C12T04	100
OMNI HINGE CLICK-ON DOWEL	BI-FOLD/PIE-CUT FULL HOLE	C12T04N	100

FEATURES: Door thickness up to 16 mm
Cup depth 11.3 mm
Clip on with various plate options



DESCRIPTION	APPLICATION	CODE	PACK SIZE
OMNI HINGE CLICK-ON SCREW IN	FULL OVERLAY 165°	C2016	100
OMNI HINGE CLICK-ON DOWEL	FULL OVERLAY 165°	C2016N	100

FEATURES: Door thickness up to 16 mm
Cup depth 11.3 mm
Clip on with various plate options



DESCRIPTION	APPLICATION	CODE	PACK SIZE
OMNI M/PLATE CLICK-ON	SCREW FIX	C31H0 - 4HOLE	500



DESCRIPTION	APPLICATION	CODE	PACK SIZE
OMNI M/PLATE CLICK-ON	10 MM MOUNTED EURO SCREW	C02H0D-10	500
OMNI M/PLATE CLICK-ON	13 MM MOUNTED EURO SCREW	C02H0D-13	500



DESCRIPTION	APPLICATION	CODE	PACK SIZE
OMNI HINGE AND PLATE SLIDE-ON SCREW IN	FULL OVERLAY	2811.007	200 PREPACK
OMNI HINGE SLIDE-ON SCREW IN	FULL OVERLAY	2809.400	200
OMNI HINGE SLIDE-ON DOWEL	FULL OVERLAY	2809.400N	200
OMNI HINGE AND PLATE SLIDE-ON SCREW IN	HALF OVERLAY	2811.015	200 PREPACK
OMNI HINGE SLIDE-ON SCREW IN	HALF OVERLAY	2809.405	200
OMNI HINGE SLIDE-ON DOWEL	HALF OVERLAY	2809.405N	200
OMNI M/PLATE SLIDE-ON	4 HOLE SCREW-IN	2809.626	200
OMNI M/PLATE SLIDE-ON	2 HOLE MOUNTED EURO SCREW	2809.526	200

FEATURES: Pre-packed



DESCRIPTION	CODE	FINISH
TIPMATIC ACTIVATOR/SOFT-CLOSE 110°	OTMSC/H	BLACK
NEXIS TIPMATIC UNSPRUNG HINGE	F015072724236	NICKEL

FEATURES:

Mechanical operation
Allows for handle free doors with soft-close action
Easy fitting

Use for doors up to 2200 mm in height and 600 mm in width
Use with GRASS Nexis Tipmatic hinge
Max door weight is 20 kg





CODE	DESCRIPTION	SIZE	PACK SIZE	FINISH
OUM301/400	OMNI UNDERMOUNT SINGLE EXTENSION 25 KG	400 MM	10	ZINC
OUM301/450	OMNI UNDERMOUNT SINGLE EXTENSION 25 KG	450 MM	10	ZINC
OUM301/500	OMNI UNDERMOUNT SINGLE EXTENSION 25 KG	500 MM	10	ZINC
OUM302/350	OMNI UNDERMOUNT FULL EXTENSION 35 KG	350 MM	10	ZINC
OUM302/400	OMNI UNDERMOUNT FULL EXTENSION 35 KG	400 MM	10	ZINC
OUM302/450	OMNI UNDERMOUNT FULL EXTENSION 35 KG	450 MM	10	ZINC
OUM302/500	OMNI UNDERMOUNT FULL EXTENSION 35 KG	500 MM	10	ZINC



CODE	DESCRIPTION	SIZE	PACK SIZE	FINISH
550-704-086X270W	OMNI SUPER STEEL DRAWER SLIDE	86 x 270	10	WHITE
550-704-086X350W	OMNI SUPER STEEL DRAWER SLIDE	86 x 350	10	WHITE
550-704-086X400W	OMNI SUPER STEEL DRAWER SLIDE	86 x 400	10	WHITE
550-704-086X450W	OMNI SUPER STEEL DRAWER SLIDE	86 x 450	10	WHITE
550-704-086X500W	OMNI SUPER STEEL DRAWER SLIDE	86 x 500	10	WHITE
550-704-086X550W	OMNI SUPER STEEL DRAWER SLIDE	86 x 550	10	WHITE
550-704-150X450W	OMNI SUPER STEEL DRAWER SLIDE	150 x 450	10	WHITE
550-704-150X500W	OMNI SUPER STEEL DRAWER SLIDE	150 x 500	10	WHITE
5501	MARKING JIG FOR DRAWER FRONTS		1	BLACK

CODE	DESCRIPTION	PACK SIZE	FINISH
4401.125	SOFT-CLOSE ADAPTER	EACH	GREY
4401.159	SOFT-CLOSE PIN FOR STEEL SIDE DRAWER	EACH	WHITE
4401.143	SOFT-CLOSE PIN FOR WOODEN DRAWER	EACH	GREY



CODE	DESCRIPTION	SIZE	PACK SIZE	FINISH
MBBF/250	OMNI BALL BEARING FULL EXTENSION 45 KG	250 MM	10	ZINC
MBBF/300	OMNI BALL BEARING FULL EXTENSION 45 KG	300 MM	10	ZINC
MBBF/350	OMNI BALL BEARING FULL EXTENSION 45 KG	350 MM	10	ZINC
MBBF/400	OMNI BALL BEARING FULL EXTENSION 45 KG	400 MM	10	ZINC
MBBF/450	OMNI BALL BEARING FULL EXTENSION 45 KG	450 MM	10	ZINC
MBBF/500	OMNI BALL BEARING FULL EXTENSION 45 KG	500 MM	10	ZINC
MBBF/550	OMNI BALL BEARING FULL EXTENSION 45 KG	550 MM	10	ZINC
MBBF/600	OMNI BALL BEARING FULL EXTENSION 45 KG	600 MM	10	ZINC

CODE	DESCRIPTION	SIZE	PACK SIZE	FINISH
EBBF/450	OMNI ECO BALL BEARING FULL EXTENSION 45 KG	450 MM	10	ZINC
EBBF/500	OMNI ECO BALL BEARING FULL EXTENSION 45 KG	500 MM	10	ZINC



CODE	DESCRIPTION	SIZE	PACK SIZE	FINISH
MBBF/350SC	OMNI BALL BEARING FULL EXTENSION SOFT-CLOSE 45 KG	350 MM	10	ZINC
MBBF/400SC	OMNI BALL BEARING FULL EXTENSION SOFT-CLOSE 45 KG	400 MM	10	ZINC
MBBF/450SC	OMNI BALL BEARING FULL EXTENSION SOFT-CLOSE 45 KG	450 MM	10	ZINC
MBBF/500SC	OMNI BALL BEARING FULL EXTENSION SOFT-CLOSE 45 KG	500 MM	10	ZINC
MBBF/550SC	OMNI BALL BEARING FULL EXTENSION SOFT-CLOSE 45 KG	550 MM	10	ZINC



TAVINEA SORTO ORGANISING SYSTEM





DESCRIPTION	CODE	SIZE	FINISH
		W x D	
TAVINEA SORTO B276 - NOVAPRO	F007130058201	276 X 500	STONE
TAVINEA SORTO B276 - NOVAPRO	F007130059201	276 X 500	SILVER
TAVINEA SORTO B276 - VIONARO AND DWD XP	F007130137201	276 X 500	GRAPHITE
TAVINEA SORTO B276 - NOVAPRO	F007130062201	276 X 550	STONE



DESCRIPTION	CODE	SIZE	FINISH
		W x D	
TAVINEA SORTO B186 - NOVAPRO	F007130086201	186 X 500	STONE
TAVINEA SORTO B186 - NOVAPRO	F007130087201	186 X 500	SILVER
TAVINEA SORTO B186 - VIONARO AND DWD XP	F007130158201	186 X 500	GRAPHITE
TAVINEA SORTO B186 - NOVAPRO	F007130090201	186 X 550	STONE



DESCRIPTION	CODE	DEPTH	FINISH
TAVINEA SORTO DIVIDER RAIL - NOVAPRO	F007130114207	500	STONE
TAVINEA SORTO DIVIDER RAIL - NOVAPRO	F007130115207	500	SILVER
TAVINEA SORTO DIVIDER RAIL - VIONARO AND DWD XP	F007130179207	500	GRAPHITE
TAVINEA SORTO DIVIDER RAIL - NOVAPRO	F007130118207	550	STONE



DESCRIPTION	CODE	SIZE	FINISH
		W x D	
TAVINEA SORTO KNIFE BLOCK - NOVAPRO	F007101995201	185 X 500	DARK ASH
TAVINEA SORTO KNIFE BLOCK - VIONARO AND DWD XP	F007102424201	185 X 500	DARK ASH



DESCRIPTION	CODE	SIZE	FINISH
		W x D	
TAVINEA SORTO KNIFE BLOCK - NOVAPRO	F007101990201	185 X 500	LIGHT ASH
TAVINEA SORTO KNIFE BLOCK - VIONARO AND DWD XP	F007102418201	185 X 500	LIGHT ASH



DESCRIPTION	CODE	SIZE	FINISH
		W x D	
TAVINEA SORTO SPICE RACK - NOVAPRO	F007101997201	185 X 500	DARK ASH
TAVINEA SORTO SPICE RACK - VIONARO AND DWD XP	F007102426201	185 X 500	DARK ASH



DESCRIPTION	CODE	SIZE	FINISH
		W x D	
TAVINEA SORTO SPICE RACK - NOVAPRO	F007101992201	185 X 500	LIGHT ASH
TAVINEA SORTO SPICE RACK - VIONARO AND XP	F007102420201	185 X 500	LIGHT ASH



DESCRIPTION	CODE	SIZE	FINISH
		W x D	
TAVINEA SORTO FOIL HOLDER - NOVAPRO	F007101999201	185 X 500	DARK ASH
TAVINEA SORTO FOIL HOLDER - VIONARO AND DWD XP	F007102428201	185 X 500	DARK ASH



DESCRIPTION	CODE	SIZE	FINISH
		W x D	
TAVINEA SORTO FOIL HOLDER - NOVAPRO	F007101994201	185 X 500	LIGHT ASH
TAVINEA SORTO FOIL HOLDER - VIONARO AND DWD XP	F007102422201	185 X 500	LIGHT ASH



DESCRIPTION	CODE	SIZE	FINISH
		W x D	
TAVINEA SORTO SQUARE ELEMENT	F007102423201	185 X 208	LIGHT ASH
TAVINEA SORTO SQUARE ELEMENT	F007102429201	185 X 208	DARK ASH

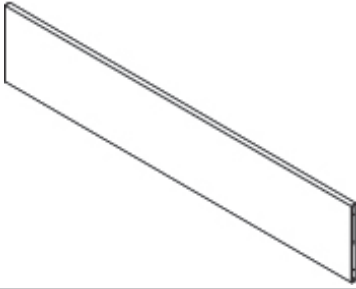

DESCRIPTION	CODE	COLOUR	PACK SIZE
TAVINEA OPTIMA DIVIDER PROFILE 1200 MM	F007130242507	GRAHITE	EACH
TAVINEA OPTIMA DIVIDER PROFILE 1200 MM	F007130243507	WHITE	EACH
TAVINEA OPTIMA DIVIDER PROFILE 1200 MM	F007130241507	SILVER	EACH

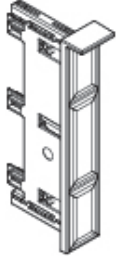

DESCRIPTION	CODE	COLOUR	PACK SIZE
TAVINEA OPTIMA PROFILE CLIP	F007130228511	GRAHITE	SET
TAVINEA OPTIMA PROFILE CLIP	F007130229511	WHITE	SET
TAVINEA OPTIMA PROFILE CLIP	F007130230511	SILVER	SET

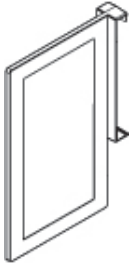

DESCRIPTION	CODE	COLOUR	PACK SIZE
TAVINEA OPTIMA SMART BOARD	F007130245211	GRAHITE	EACH
TAVINEA OPTIMA SMART BOARD	F007130246211	WHITE	EACH
TAVINEA OPTIMA SMART BOARD	F007130247211	SILVER	EACH

FEATURES: Dividing system for pot drawers
Tool-free installation
Tool-free adjustment
Can be retrofitted

Colour coordinated with drawer sides
Can work with Vionaro, Novapro Scala and wooden drawers
Organises the storage space for clear and tidy arrangement
*Only applicable for 185 mm height sides





DESCRIPTION	CODE	SIZE	FINISH
		W x D	
NOVA PRO 450 MM CUTLERY INSERT	CNP450/500WH	360 X 480	WHITE
VIONARO 450 MM CUTLERY INSERT	CVI450/500WH	375 X 473	WHITE
DWD XP 450 MM CUTLERY INSERT	CXP450/500WH	356 X 473	WHITE
INTEGRA 450 MM CUTLERY INSERT	CIN450/500WH	387 X 480	WHITE
NOVA PRO 450 MM CUTLERY INSERT	CNP450/500SIL	360 X 480	SILVER
VIONARO 450 MM CUTLERY INSERT	CVI450/500SIL	375 X 473	SILVER
DWD XP 450 MM CUTLERY INSERT	CXP450/500SIL	356 X 473	SILVER
NOVA PRO 450 MM CUTLERY INSERT	CNP450/500GRP	360 X 480	GRAPHITE
VIONARO 450 MM CUTLERY INSERT	CVI450/500GRP	375 X 473	GRAPHITE



DESCRIPTION	CODE	SIZE	FINISH
		W x D	
NOVA PRO 600 MM CUTLERY INSERT	CNP600/500WH	510 X 480	WHITE
VIONARO 600 MM CUTLERY INSERT	CVI600/500WH	525 X 473	WHITE
DWD XP 600 MM CUTLERY INSERT	CXP600/500WH	506 X 473	WHITE
INTEGRA 600 MM CUTLERY INSERT	CIN600/500WH	537 X 480	WHITE
NOVA PRO 600 MM CUTLERY INSERT	CNP600/500SIL	510 X 480	SILVER
VIONARO 600 MM CUTLERY INSERT	CVI600/500SIL	525 X 473	SILVER
DWD XP 600 MM CUTLERY INSERT	CXP600/500SIL	506 X 473	SILVER
NOVA PRO 600 MM CUTLERY INSERT	CNP600/500GRP	510 X 480	GRAPHITE
VIONARO 600 MM CUTLERY INSERT	CVI600/500GRP	525 X 473	GRAPHITE



DESCRIPTION	CODE	SIZE	FINISH
		W x D	
NOVA PRO 900 MM CUTLERY INSERT	CNP900/500WH	810 X 480	WHITE
VIONARO 900 MM CUTLERY INSERT	CVI900/500WH	825 X 473	WHITE
DWD XP 900 MM CUTLERY INSERT	CXP900/500WH	806 X 473	WHITE
INTEGRA 900 MM CUTLERY INSERT	CIN900/500WH	837 X 480	WHITE
NOVA PRO 900 MM CUTLERY INSERT	CNP900/500SIL	810 X 480	SILVER
VIONARO 900 MM CUTLERY INSERT	CVI900/500SIL	825 X 473	SILVER
DWD XP 900 MM CUTLERY INSERT	CXP900/500SIL	806 X 473	SILVER
NOVA PRO 900 MM CUTLERY INSERT	CNP900/500GRP	810 X 480	GRAPHITE
VIONARO 900 MM CUTLERY INSERT	CVI900/500GRP	825 X 473	GRAPHITE



DESCRIPTION	CODE	SIZE	FINISH
		W x D	
CLASSICO KNIFE INSERT	CKNIFE/WH	165 X 440	WHITE
CLASSICO KNIFE INSERT	CKNIFE/GRP	165 X 440	GRAPHITE
CLASSICO KNIFE INSERT	CKNIFE/SIL	165 X 440	SILVER



DESCRIPTION	CODE	SIZE	FINISH
		W x D	
CLASSICO SPICE INSERT	CSPICE/WH	165 X 440	WHITE
CLASSICO SPICE INSERT	CSPICE/GRP	165 X 440	GRAPHITE
CLASSICO SPICE INSERT	CSPICE/SIL	165 X 440	SILVER



DESCRIPTION	CODE	SIZE	FINIS
RUBBER CANVAS MAT	CMAT/SIL	25 M X 480 MM	SILVER
RUBBER CANVAS MAT	CMAT/GRP	25 M X 480 MM	GRAPHITE
RUBBER CANVAS MAT	CMAT/GRP 550	25 M X 530 MM	GRAPHITE



DESCRIPTION	CODE	SIZE	FINIS
RUBBER MAT SOLID	CMAT/WH	25 M X 480 MM	WHITE
RUBBER MAT SOLID	CMAT/WH 550	25 M X 530 MM	WHITE



DESCRIPTION	CODE	SIZE	FINIS
RUBBER MAT GLOBE	CMAT/BLK	25 M X 480 MM	BLACK
RUBBER MAT GLOBE	CMAT/BLK 550	25 M X 530 MM	BLACK

FEATURES: Our non-slip mats are highly practical and offer additional benefits. The anti-slip surface prevents objects from sliding about when drawers are opened and closed. It can also be easily removed for cleaning. Our mats can also be cut to fit most drawer sizes. *Sold per/m





DESCRIPTION	CODE	SIZE	FINISH
GOLA HANDLE SLIM C ALU	SNA211CS	49 MM X 3 M	ALU
GOLA HANDLE SLIM L ALU	SNA211LS	40 MM X 3 M	ALU
GOLA HANDLE SLIM C BLACK	SNA211CB	49 MM X 3 M	BLACK
GOLA HANDLE SLIM L BLACK	SNA211LB	40 MM X 3 M	BLACK
GOLA HANDLE SLIM C WHITE	SNA211CW	49 MM X 3 M	WHITE
GOLA HANDLE SLIM L WHITE	SNA211LB	40 MM X 3 M	WHITE
FIXING BRACKET SLIM	SNA/F	-	STEEL

FEATURES: Allows for more height spacing inside the drawers
 Square cut out
 Makes vertical applications possible
 End caps available for both options
 More accurate cutting for mitre joints
 Straight edge profile gives more elegant look

STANDARD:

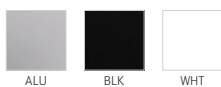

Custom: Other colours available on request, minimum order of 10 lengths.



DESCRIPTION	CODE	SIZE	FINISH
GOLA HANDLE C ALU	NA211CS	65 MM X 3 M	ALU
GOLA HANDLE L ALU	NA211LS	50 MM X 3 M	ALU
GOLA HANDLE C BLACK	NA211CSB	65 MM X 3 M	BLACK
GOLA HANDLE L BLACK	NA211LSB	50 MM X 3 M	BLACK
GOLA HANDLE C WHITE	NA211CSW	65 MM X 3 M	WHITE
GOLA HANDLE L WHITE	NA211LSW	50 MM X 3 M	WHITE
FIXING BRACKET	NA/F	-	STEEL

FEATURES: Round cut out
 End caps available for all colours

STANDARD:



Custom: Other colours available on request, minimum order of 10 lengths.



DESCRIPTION	CODE	SIZE	FINISH
STRIP HANDLE 32 MM ALU	VD5_ALU	3 M	ALU
STRIP HANDLE 32 MM BRUSHED STEEL FINISH	VD5_SS	3 M	S/STEEL
STRIP HANDLE 32 MM WHITE	VD5_WHT	3 M	WHITE
STRIP HANDLE 32 MM BLACK	VD5_BLK	3 M	BLACK
STRIP HANDLE 32 MM GRAPHITE	VD5_GRP	3 M	GRAPHITE

FEATURES: Suitable for cabinet doors and drawer fronts.
 Vertical mounting for all doors
 Horizontal mounting for drawers
 Can be cut to size
 Can be powder coated
 Black & Alu available in pre-cut sizes of 100 mm, 200 mm and 300 mm

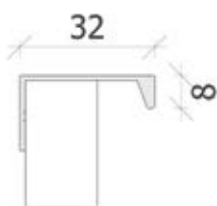

STANDARD:

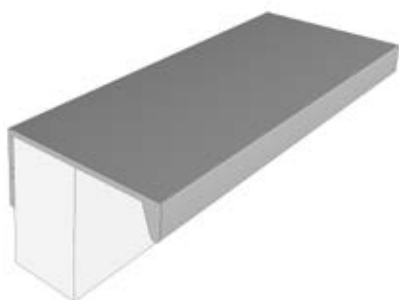

DESCRIPTION	CODE	SIZE	FINISH
STRIP HANDLE 38 MM ALU	VD6_ALU	3 M	ALU
STRIP HANDLE 38 MM WHITE	VD6_WHT	3 M	WHITE
STRIP HANDLE 38 MM BLACK	VD6_BLK	3 M	BLACK
STRIP HANDLE 38 MM GRAPHITE	VD6_GRP	3 M	GRAPHITE

FEATURES: Suitable for cabinet doors and drawer fronts.
 Vertical mounting for all doors
 Horizontal mounting for drawers
 Can be cut to size
 Can be powder coated
 Black & Alu available in pre-cut sizes of 100 mm, 200 mm and 300 mm

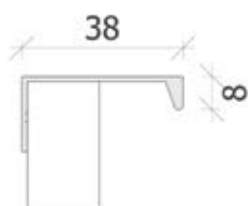

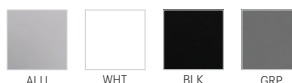

STANDARD:





DESCRIPTION	CODE	SIZE	FINISH
FINGER GRIP HANDLE SHORT ALUMINIUM	VD9_ALU	3 M	ALU
FINGER GRIP HANDLE SHORT BLACK	VD9_BLK	3 M	BLACK

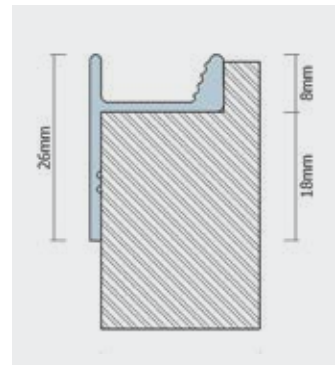
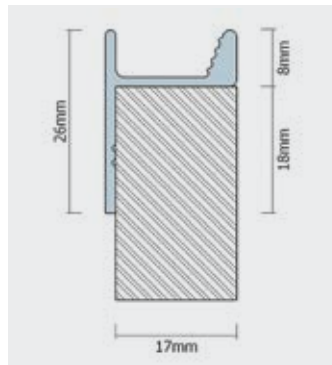

FEATURES: Cabinet Doors and Drawer Fronts
 Top or bottom mounted to doors and drawer fronts
 Can be used in conjunction with VD10

STANDARD:   ON REQUEST:   



DESCRIPTION	CODE	SIZE	FINISH
FINGER GRIP HANDLE LONG ALUMINIUM	VD10_ALU	3 M	ALU
FINGER GRIP HANDLE LONG BLACK	VD10_BLK	3 M	BLACK
FINGER GRIP HANDLE LONG WITH LIP	VD10.LIP_ALU	3 M	ALU
FINGER GRIP HANDLE LONG WITH LIP	VD10.LIP_BLK	3 M	BLACK

FEATURES: Cabinet Doors and Drawer Fronts
 Top or bottom mounted to doors and drawer fronts
 Can be used in conjunction with VD9

STANDARD:   ON REQUEST:   

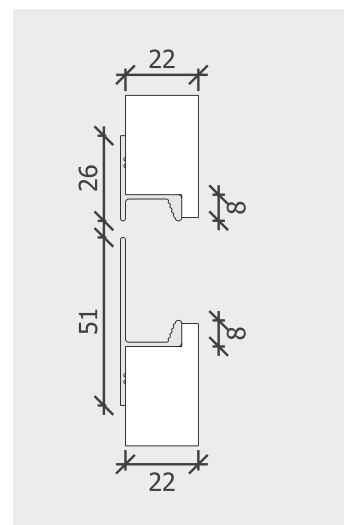
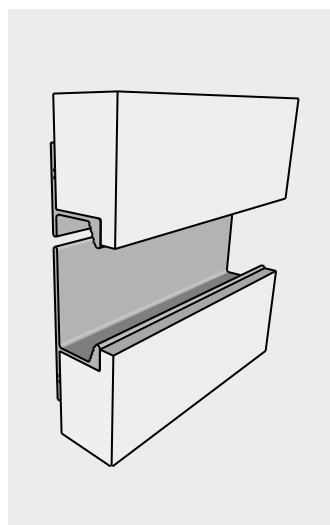
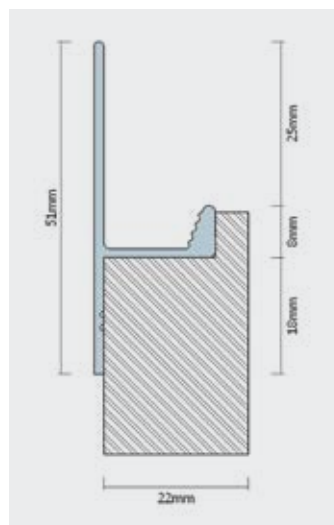
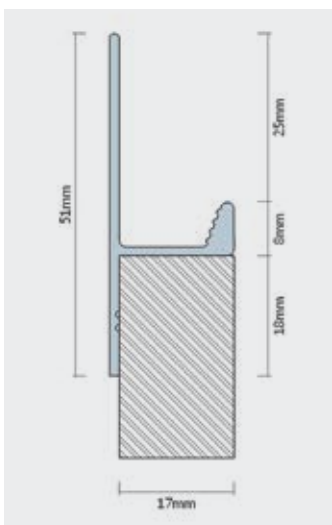



DESCRIPTION	CODE	FINISH
CORNER JOINT CONNECTOR FOR 2 SIDES	VC002_blk	BLACK
CORNER JOINT CONNECTOR FOR 3 SIDES	VC003_blk	BLACK
CORNER JOINT CONNECTOR FOR 4 SIDES	VC004_blk	BLACK
CORNER JOINT CONNECTOR FOR 5 SIDES	VC005_blk	BLACK
CORNER JOINT CONNECTOR FOR 3 SIDES + ADJUSTABLE FOOT	VC003.1_blk	BLACK
CORNER JOINT CONNECTOR FOR 4 SIDES + ADJUSTABLE FOOT	VC004.1_blk	BLACK



APPLICATIONS: Intergrated into the kitchen, freestanding furniture and visual room designs.

FINISHES: On Request - White, Grey and Graphite

BENEFITS: Endless possibilities
Modular and flexible use
Simple assembly
Easy delivery
Wide selection of corner joints

SUPPLIED: Components and profiles only
Standard kits
Custom sizes and layouts - supplied cut to size and drilled, ready to assemble
*Screws included

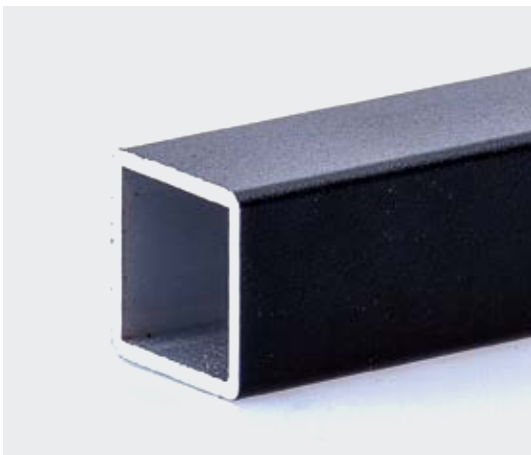

DESCRIPTION	SIZE	CODE	FINISH
FRAME PROFILE	20 x 20 MM	vCUBE_20x20_blk	BLACK
FRAME PROFILE WITH LIP	20 x 20 MM	vCUBE_20x20.lip_blk	BLACK
STRIP FOR GLASS INSERT	1200 MM	VC_Glass4_blk	GLASS
STRIP FOR GLASS INSERT	1200 MM	VC_Glass6_blk	GLASS

*Strip fixed with double sided tape included.

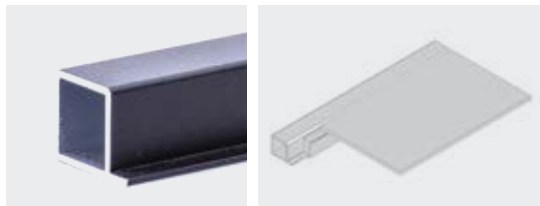

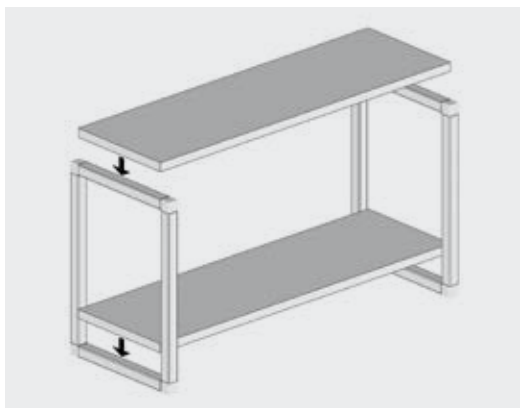

CODE	HEIGHT	WIDTH	DEPTH	COLOUR
VC_FRAME7230_blk	720 MM	-	300 MM	BLACK

*Shelf frames: for timber shelves (2 frames ready to fix to the wall)

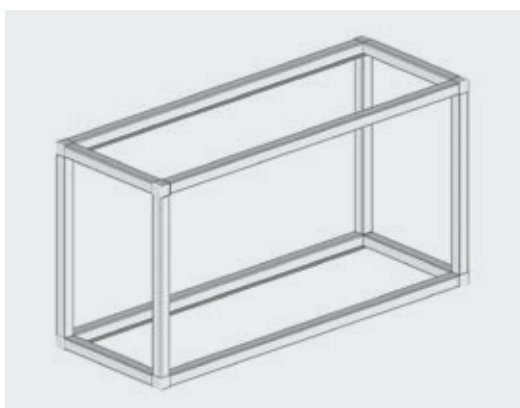

CODE	HEIGHT	WIDTH	DEPTH	COLOUR
VC_CUBE306030_blk.2W	300 MM	600 MM	300 MM	BLACK
VC_CUBE309030_blk.2W	300 MM	900 MM	300 MM	BLACK
VC_CUBE456030_blk.2W	450 MM	600 MM	300 MM	BLACK
VC_CUBE459030_blk.2W	450 MM	900 MM	300 MM	BLACK

*vCUBE frame: for 2 timber shelves on the top and bottom

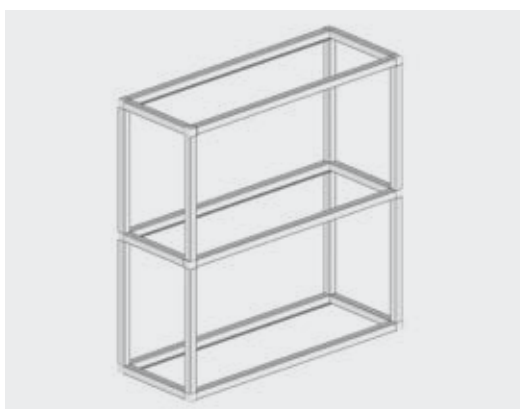

CODE	HEIGHT	WIDTH	DEPTH	COLOUR
VC_CUBE726030_blk.3W	720 MM	600 MM	300 MM	BLACK
VC_CUBE729030_blk.3W	720 MM	900 MM	300 MM	BLACK

*Top cabinet vCUBE frame: for 3 timber shelves on the top, bottom and middle

CODE	HEIGHT	WIDTH	DEPTH	COLOUR
VC_CUBE906030_blk.4W	900 MM	600 MM	300 MM	BLACK
VC_CUBE909030_blk.4W	900 MM	900 MM	300 MM	BLACK

*Top cabinet vCUBE frame: for 4 timber shelves on the top, bottom and 2 x middle (equally spaced shelves)



CODE	HEIGHT	WIDTH	DEPTH	COLOUR
VC_CUBE7212030_blk.3W	720 MM	1200 MM	300 MM	BLACK
VC_CUBE9012030_blk.4W	900 MM	1200 MM	300 MM	BLACK

*Top cabinet vCUBE frame: 2 Sections for 3/4 timber shelves on the top, bottom and middle (equally spaced shelves)

CUSTOM SIZES AND LAYOUTS
Supplied cut to size and drilled, ready to assemble. Delivered flat packed.

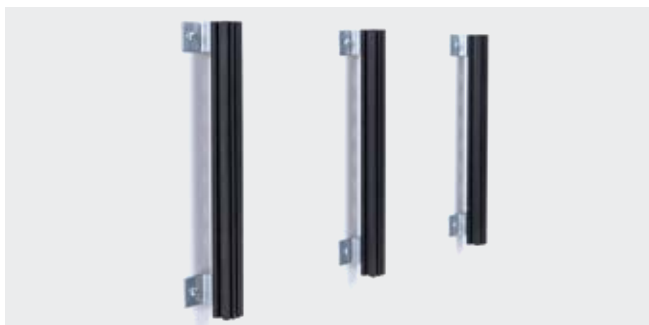

DESCRIPTION	CODE	FINISH
FIX VERTICAL PANEL KIT	VW_UPRIGHT.KIT_BLK	BLACK



DESCRIPTION	CODE	FINISH
CABINET HANGERS (PAIR)	VW008	BLACK



DESCRIPTION	CODE	FINISH
STRAIGHT SHELF BRACKET 300 MM	VW_SHELF.30_BLK	BLACK
STRAIGHT SHELF BRACKET 400 MM	VW_SHELF.40_BLK	BLACK
STRAIGHT SHELF BRACKET 550 MM	VW_SHELF.55_BLK	BLACK



DESCRIPTION	CODE	FINISH
ANGLED SHELF BRACKET 300 MM	VW_SHELF.30ANG_BLK	BLACK
ANGLED SHELF BRACKET 550 MM	VW_SHELF.55ANG_BLK	BLACK

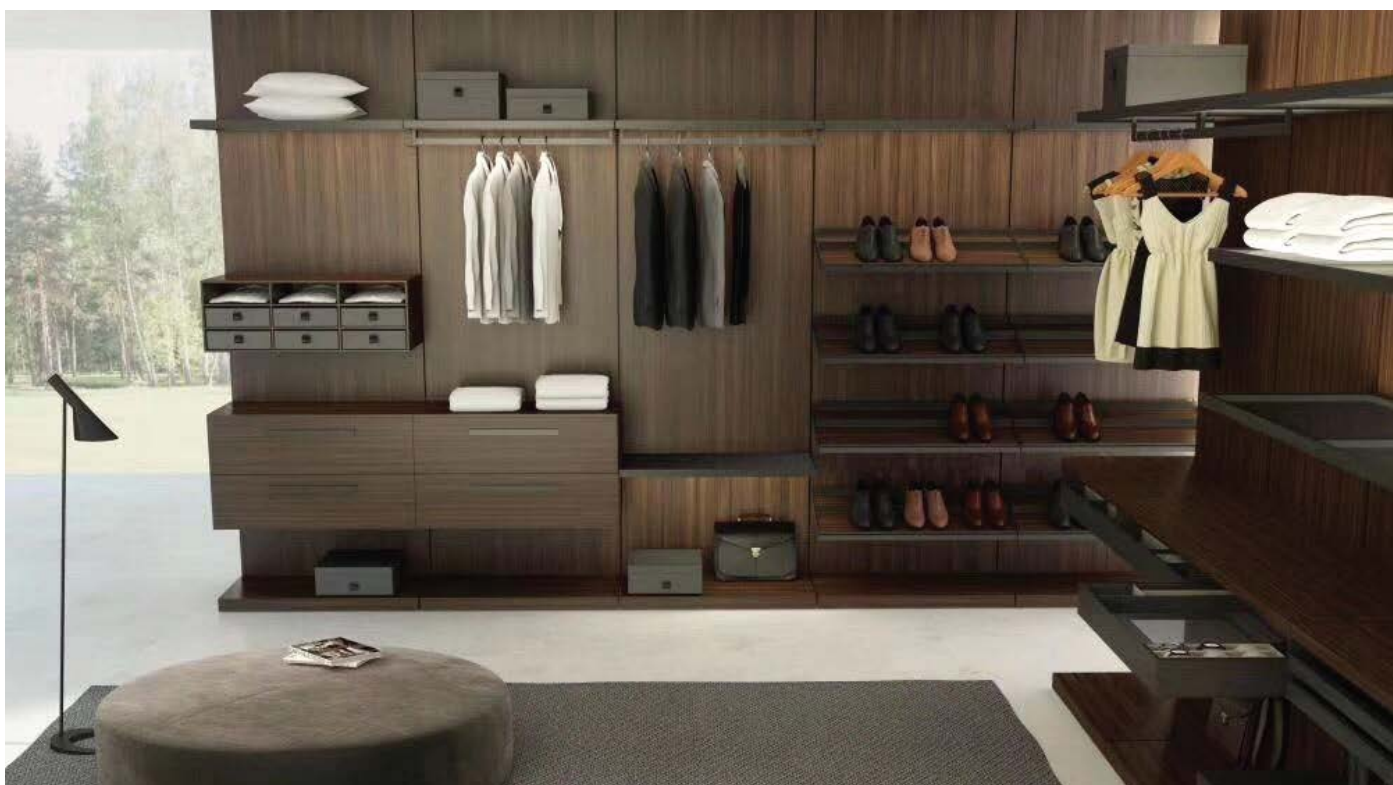



DESCRIPTION	CODE	FINISH
2 DOOR WHEEL SET + 2 X 3M TRACKS	VS_M01_KIT_ALU	ALU
2 DOOR WHEEL SET + 2 X 3M TRACKS	VS_M01_KIT_BLK	BLACK

Regular inside fit system. Insert track is recessed into the top and bottom carcass.

APPLICATIONS: Base or top cabinets in kitchens, free standing furniture

DOORS: Door Types: Wood and aluminium frames
 Door Thickness: 16 - 25mm
 Spacing of Top and Bottom tracks is dependent on door thickness choice
 Door Weight: 40kg
 Door Size: 1500mm x 900 mm (recommended)

NOTES: Smooth sliding action with easy height adjustment.
 Easy to drill and fit wheelsets.
 Optional soft closer: VS_M01_Softcloser (for 2 doors)

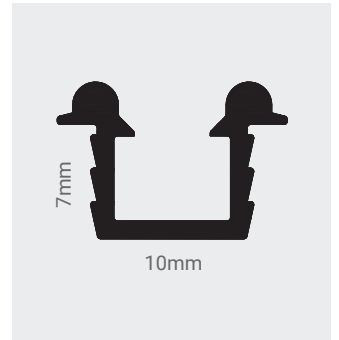
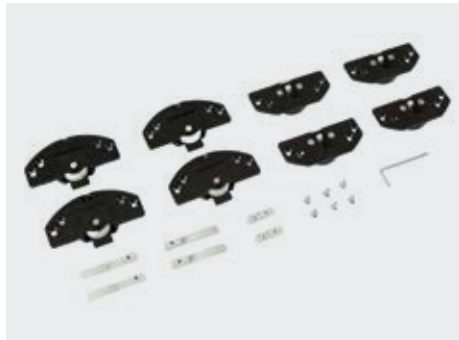
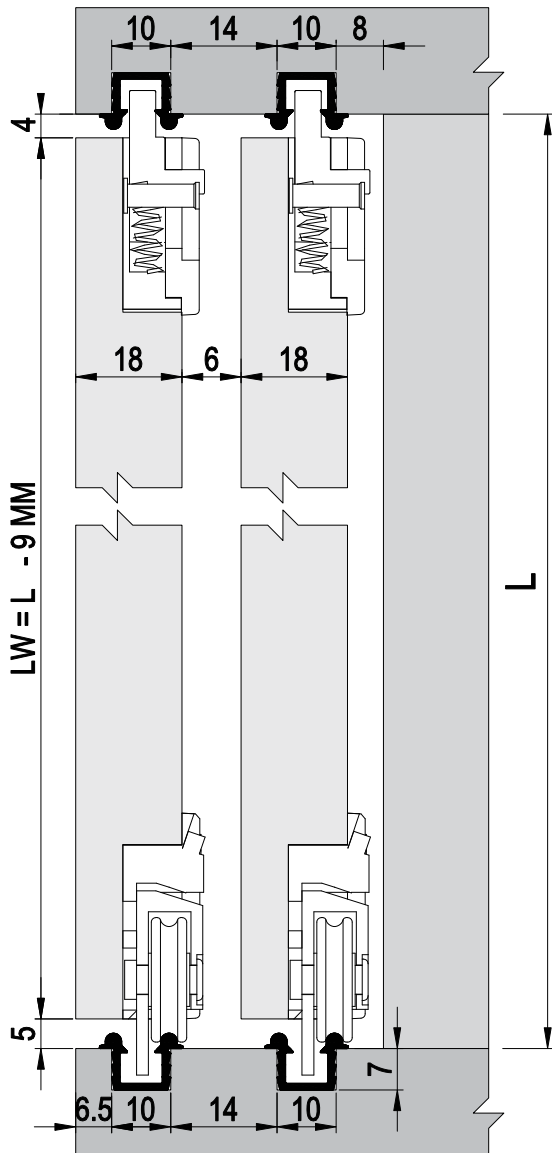



DESCRIPTION	CODE	FINISH
3M TRACK, WHEEL SETS + SOFT CLOSERS FOR 2 DOORS	VS_M02.2DR	-
3M TRACK, WHEEL SETS + SOFT CLOSERS FOR 3 DOORS	VS_M02.3DR	-

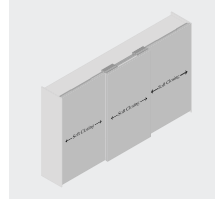
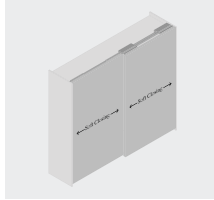

APPLICATIONS: Wardrobe sliding doors / pantry cupboards
2, 3 or 4 door systems - available as kits or with complete built up doors to size

DOORS: Door Types: Wood / Board / Alu frames with glass or mirror
Door Thickness: 16mm to 25mm
Door Weight: up to 80 kg's / Min Door Weight: 25 kg's
Door Size: 2400mm x 1200mm (recommended)
Door Height: up to 2600mm / Door Width: 600mm to 1200mm

NOTES: Integrated Soft Close comes standard on all doors - opening and closing
Smooth sliding action with easy adjustment
Build a strong sturdy carcass with no flex on the top, to accommodate the door weight and ensure allowances for bottom guide are built in.

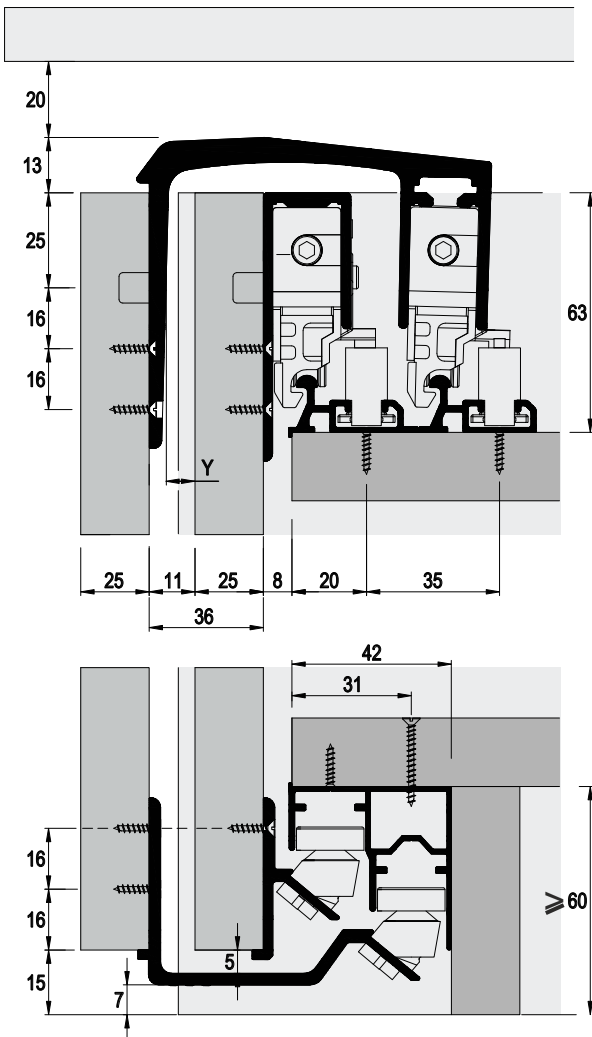

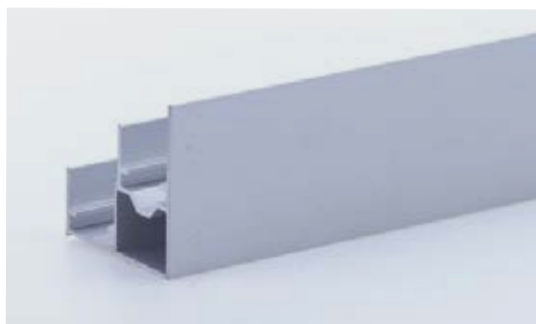

DESCRIPTION	SIZE	CODE	FINISH
TOP TRACK	3M	VS_M02_TTRACK3M	-

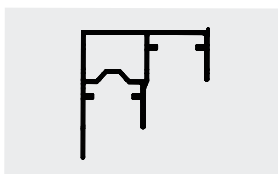

DESCRIPTION	SIZE	CODE	FINISH
BOTTOM TRACK	3M	VS_M02_BTRACK3M	-

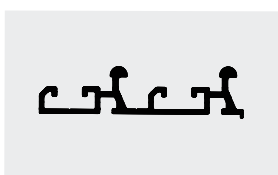

DESCRIPTION	SIZE	CODE	FINISH
2 DOOR WHEEL SET W/ SOFT CLOSERS	-	VS_M02_WS.2DR	-



DESCRIPTION	SIZE	CODE	FINISH
3 DOOR WHEEL SET W/ SOFT CLOSERS	-	VS_M02_WS.3DR	-



DESCRIPTION	CODE	FINISH
3M TRACK, WHEEL SETS + SOFT CLOSERS FOR 2 DOORS	VS_M03.2DR	-
3M TRACK, WHEEL SETS + SOFT CLOSERS FOR 3 DOORS	VS_M03.3DR	-

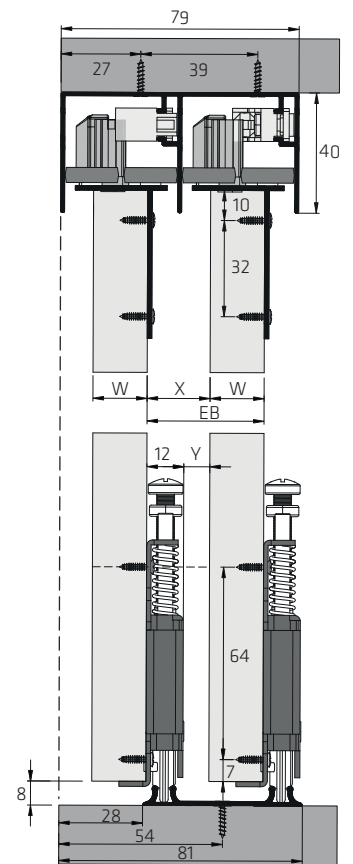
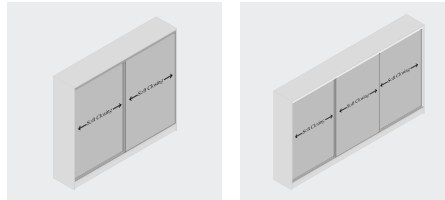

APPLICATIONS: Wardrobe sliding doors
2, 3, or 4 door systems - available as kits or with complete built up doors to size

DOORS:
Door Types: Glass, mirror and wood
Door Thickness: 16mm to 22mm
Door Weight: Up to 60 kg's / Min Door Weight: 22 kg's
Door Size: 2440mm x 1200mm (recommended)
Door Height: Up to 2500mm / Door Width: 600mm to 1200mm

NOTES:
Integrated Soft Close comes standard on all doors - opening and closing
Easy soft close adjustment
Smooth sliding action with easy height adjustment
The principles of level, plumb and square apply for all types of sliding doors.
We recommend that you do not rely on walls, floors and ceilings to be perfect. It is best to build a carcass for your sliding doors wherever possible.





DESCRIPTION	SIZE	CODE	FINISH
TOP TRACK	3M	VS_M03_TTRACK3M	-
BOTTOM TRACK	3M	VS_M02_BTRACK3M	-

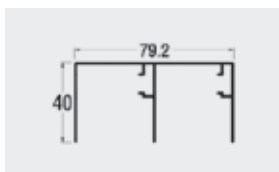

DESCRIPTION	SIZE	CODE	FINISH
BOTTOM TRACK	3M	VS_M03_BTRACK3M	-

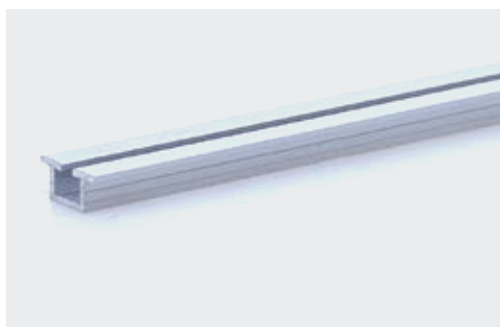

DESCRIPTION	SIZE	CODE	FINISH
INSERT TRACK 3M	3M	VS_INS.TRACK3M	-

*insert track for M03 & M04

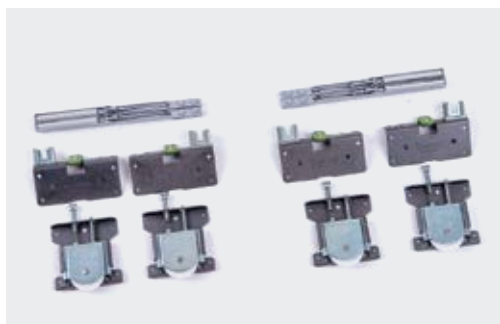
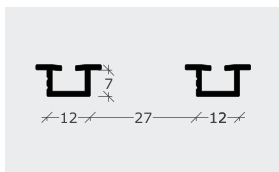

DESCRIPTION	SIZE	CODE	FINISH
2 DOOR WHEEL SET W/ SOFT CLOSERS	-	VS_M03_WS.2DR	-



DESCRIPTION	SIZE	CODE	FINISH
3 DOOR WHEEL SET W/ SOFT CLOSERS	-	VS_M03_WS.3DR	-



DESCRIPTION	CODE	FINISH
40KG WINGSLIDE WHEEL SET FOR 2 DOORS + 1,5M TOP TRACK	VS_M05_2DRKIT_ALU	ALU
40KG WINGSLIDE WHEEL SET FOR 2 DOORS + 1,5M TOP TRACK	VS_M05_2DRKIT_BLK	BLACK

Designed for top hanging folding wardrobe sliding doors where limited space for cabinet access is required.

APPLICATIONS: Wardrobes, scullery and cabinet doors
2 or 4 door applications

DOORS: Door Types: Aluminium frame and Wood doors
Door Thickness: 16 - 22mm
Spacing of Top and Bottom tracks is dependent on door thickness choice
Door Weight: 40kg for 2 doors
Door Size: 2400mm x 600 mm (recommended)

NOTES: Quick and easy installation.
Top rail is fitted to the top carcass. Doors then fold and slide with the double hinge system on the 2nd door.
(Excludes hinges on carcass side)

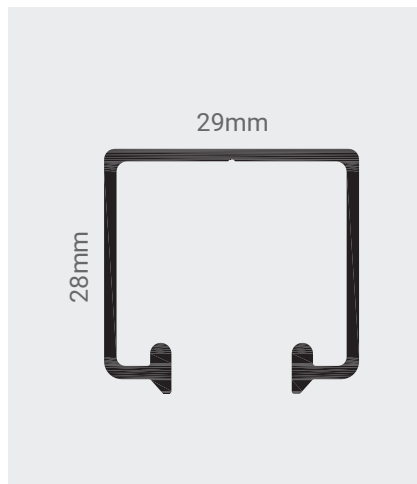
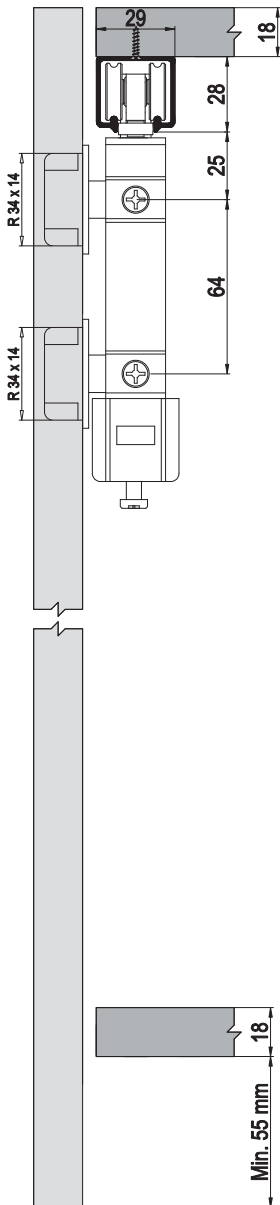



DESCRIPTION	CODE	FINISH
60KG DOORSLIDE SYSTEM, 2WAY SOFT CLOSE + 2M TOP TRACK	VS_M20.60_KIT_ALU	ALU
60KG DOORSLIDE SYSTEM, 2WAY SOFT CLOSE + 2M TOP TRACK	VS_M20.60_KIT_BLK	BLACK
120KG DOORSLIDE SYSTEM, 2WAY SOFT CLOSE + 2M TOP TRACK	VS_M20.120_KIT_ALU	ALU
120KG DOORSLIDE SYSTEM, 2WAY SOFT CLOSE + 2M TOP TRACK	VS_M20.120_KIT_BLK	BLACK

APPLICATIONS: Single or 2 door bathroom or internal door applications

DOORS: Door Thickness: 25mm - 60mm
 Door Weight: (M20.60) 60kg per door | (M20.120) 120kg per door
 Door Height: Max 2600mm
 Door Width: (M20.60) Min 610mm | (M20.120) Min 830mm

NOTES: Integrated two way soft closing system.
 All fixing brackets and guides included in kit.

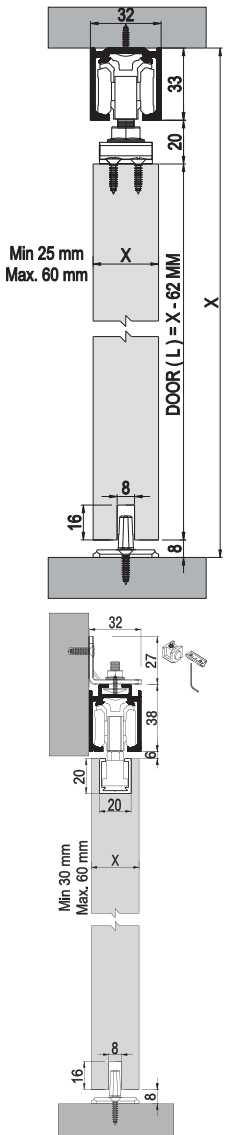



DISPLAY WINE





DESCRIPTION	CODE	SIZE	FINISH
DISPLAY PIN - SINGLE BOTTLE_SILVER	DP_SINGLE_SILV	1 BOTTLE SET	SILVER
DISPLAY PIN - DOUBLE BOTTLE_SILVER	DP_DOUBLE_SILV	2 BOTTLE SET	SILVER
DISPLAY PIN - TRIPLE BOTTLE_SILVER	DP_TRIPLE_SILV	3 BOTTLE SET	SILVER



DESCRIPTION	CODE	SIZE	FINISH
DISPLAY PIN - SINGLE BOTTLE_BLACK	DP_SINGLE_BLK	1 BOTTLE SET	BLACK
DISPLAY PIN - DOUBLE BOTTLE_BLACK	DP_DOUBLE_BLK	2 BOTTLE SET	BLACK
DISPLAY PIN - TRIPLE BOTTLE_BLACK	DP_TRIPLE_BLK	3 BOTTLE SET	BLACK

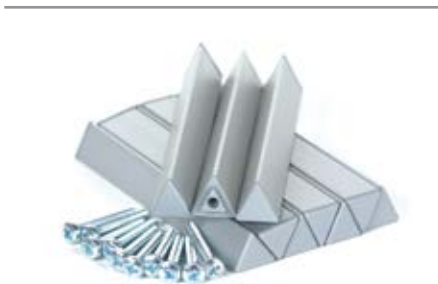

DESCRIPTION	CODE	QTY	FINISH
VINOWALL PINS WITH 50 MM SCREW - 150MM_ALU	V_PINS10_ALU	10	ALU
VINOWALL PINS WITH 50 MM SCREW - 150MM_ALU	V_PINS100_ALU	100	ALU



DESCRIPTION	CODE	QTY	FINISH
VINOWALL PINS WITH 50 MM SCREW - 150MM_BLACK	V_PINS10_BLK	10	BLACK
VINOWALL PINS WITH 50 MM SCREW - 150MM_BLACK	V_PINS100_BLK	100	BLACK





DESCRIPTION	CODE	SIZE	FINISH
WINE CRADLE WITH SCREWS - 150MM_BLACK	WCRADLE.10_BLK	10	BLACK
WINE CRADLE WITH SCREWS - 150MM_BLACK	WCRADLE.100_BLK	100	BLACK



DESCRIPTION	CODE	SIZE	FINISH
WINE CRADLE MAX WITH SCREWS - DOUBLE BOTTLE - 150MM_BLACK	WCRADLE_MAX.10_BLK	10	BLACK



DESCRIPTION	CODE	SIZE	FINISH
BLACK SPINE WITH BLACK CRADLES_700 MM	SPINE_700.BBLK	7 BOTTLES	BLACK
BLACK SPINE WITH BLACK CRADLES_1400 MM	SPINE_1400.BBLK	14 BOTTLES	BLACK
BLACK SPINE WITH BLACK CRADLES_2100 MM	SPINE_2100.BBLK	21 BOTTLES	BLACK



DESCRIPTION	CODE	SIZE	FINISH
BLACK SPINE WITH BLACK CRADLE MAX_700 MM	SPINE.MAX_700.BBLK	14 BOTTLES	BLACK
BLACK SPINE WITH BLACK CRADLE MAX_1400 MM	SPINE.MAX_1400.BBLK	28 BOTTLES	BLACK
BLACK SPINE WITH BLACK CRADLE MAX_2100 MM	SPINE.MAX_2100.BBLK	42 BOTTLES	BLACK





DESCRIPTION	CODE	QTY	FINISH
WINE SHELF BLACK FRAME, BLACK PANEL - CORK FACING	SHELF_566X297_B.BLK	5 BOTTLES	BLACK
WINE SHELF BLACK FRAME, BLACK PANEL - CORK FACING	SHELF_866X297_B.BLK	8 BOTTLES	BLACK
WINE SHELF BLACK FRAME, BLACK PANEL - CORK FACING	SHELF_1166X297_B.BLK	11 BOTTLES	BLACK





DESCRIPTION	CODE	SIZE	FINISH
ROUND WINE PIN 12 MM_10	WINEPIN_12MM_BLK_10	12 MM X 180 MM	BLACK
ROUND WINE PIN 12 MM_100	WINEPIN_12MM_BLK_100	12 MM X 180 MM	BLACK



DESCRIPTION	CODE	SIZE	FINISH
ROUND WINE PIN 22 MM_10	WINEPIN_22MM_BLK_10	22 MM X 150 MM	BLACK
ROUND WINE PIN 22 MM_100	WINEPIN_22MM_BLK_100	22 MM X 150 MM	BLACK



DESCRIPTION	CODE	SIZE	FINISH
SOLO WINE PIN_10	SOLO_PIN_BLK_10	73 MM X 175 MM	BLACK
SOLO WINE PIN_100	SOLO_PIN_BLK_100	73 MM X 175 MM	BLACK





DESCRIPTION	CODE	SIZE	FINISH
WINE CRADLE BASE TO BASE	WCRADLE.B2B.10_BLK	20 BOTTLES	BLACK
WINE CRADLE BASE TO BASE 700 MM SPINE	SPINE_700.B2B.BLK	14 BOTTLES	BLACK
WINE CRADLE BASE TO BASE 1400 MM SPINE	SPINE_1400.B2B.BLK	28 BOTTLES	BLACK
WINE CRADLE BASE TO BASE 2100 MM SPINE	SPINE_2100.B2B.BLK	42 BOTTLES	BLACK



DESCRIPTION	CODE	SIZE	FINISH
THE FLOATING WINE SHELF 380 MM X 115 MM	FWS_380MMBLK	1 BOTTLE	BLACK
THE FLOATING WINE SHELF 740 MM X 115 MM	FWS_740MMBLK	2 BOTTLES	BLACK
THE FLOATING WINE SHELF 1105 MM X 115 MM	FWS_1105MMBLK	3 BOTTLES	BLACK





DESCRIPTION	CODE	+	ADD	+	ADD	+	ADD	SIZE	FINISH
	300 / 1800 FRAME	FULL EXTENSION SLIDE	SOFT-CLOSE	5 BASKETS					
SOLID BASE PULL-OUT LARDER	295A		295K		295O		296+	300 MM	CHROME
SOLID BASE PULL-OUT LARDER	295 GRAPHITE		295K GRAPHITE		295O		296+GREY	300 MM	GRAPHITE

FEATURES: Soft-close (Optional)
 Weight capacity - 80 kg
 Solid base baskets
 Available in Chrome and Graphite

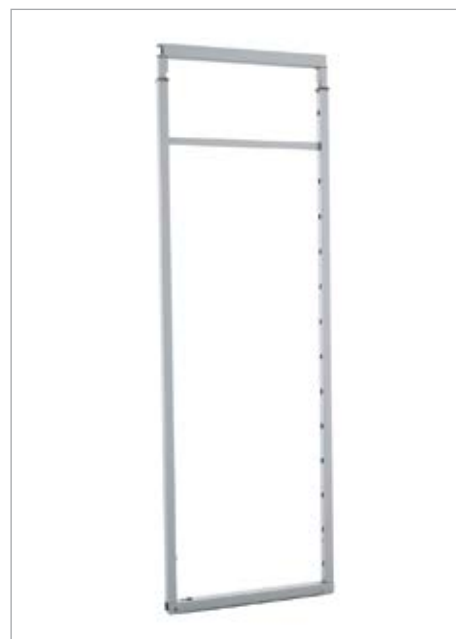
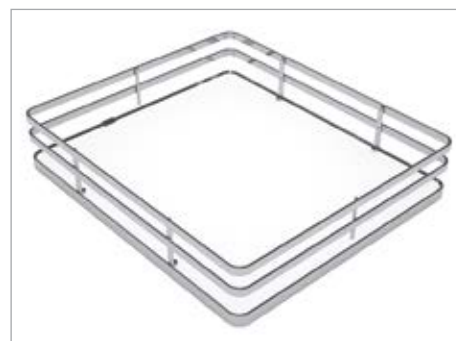

DESCRIPTION	CODE	SIZE	FINISH
PULL-OUT LARDER 300 MM	255K+255A+253/300	300 MM	CHROME/WHITE
PULL-OUT LARDER 450 MM	255K+255A+253/450	450 MM	CHROME/WHITE
PULL-OUT LARDER 600 MM	255K+255A+253/600	600 MM	CHROME/WHITE

FEATURES:

- Soft-close
- Weight capacity - 120 kg
- Full extension slide
- Solid base
- Available in Chrome
- Access from both sides
- Grocery storage
- Adjustable frame height from 1880 h - 2180 h



DESCRIPTION	CODE	+	ADD	SIZE	FINISH
			NOVA PRO RUNNER		
SOLID BASE PULL-OUT	119+GRASS 450		F101108276211	450 MM	CHROME
SOLID BASE PULL-OUT	119+GRASS 600		F101108276211	600 MM	CHROME
SOLID BASE PULL-OUT	119+GRASS 900		F101108276211	900 MM	CHROME

DESCRIPTION	CODE	+	ADD	SIZE	FINISH
			NOVA PRO RUNNER		
SOLID BASE PULL-OUT	119+GRASS 450 GR		F101108276211	450 MM	GRAPHITE
SOLID BASE PULL-OUT	119+GRASS 600 GR		F101108276211	600 MM	GRAPHITE
SOLID BASE PULL-OUT	119+GRASS 900 GR		F101108276211	900 MM	GRAPHITE

FEATURES: Soft-close
 Weight capacity - 40 kg
 Full extension drawer slide
 Fully synchronised
 Solid base
 Available in Chrome and Graphite



DESCRIPTION	CODE	SIZE	FINISH
SIGE 3/4 CAROUSEL FLAT WIRE	363+	800 MM	CHROME
SIGE 3/4 CAROUSEL FLAT WIRE	363+ GRAPHITE	800 MM	GRAPHITE

DESCRIPTION	CODE	SIZE	FINISH
SIGE 3/4 CAROUSEL ROUND WIRE	363I	700 MM	CHROME

FEATURES:	Retrofit	Assembly on cabinet base	2 x Shelves per set
	Shelf mounted	Height adjustment + 3.5 m	



DESCRIPTION	CODE	SIZE	MIN DOOR SIZE	FINISH
SIGE BLIND CORNER LEFT	371+LH SC	900 MM	450 MM	CHROME
SIGE BLIND CORNER RIGHT	371+RH SC	900 MM	450 MM	CHROME
SIGE BLIND CORNER LEFT	371+LH GRP SC	900 MM	450 MM	GRAPHITE
SIGE BLIND CORNER RIGHT	371+RH GRP SC	900 MM	450 MM	GRAPHITE

- FEATURES:**
- Retrofit
 - Shelf mounted
 - Weight capacity 25 kg per shelf
 - More stability
 - Easy to install
 - 2 x Shelves per set
 - Soft-close

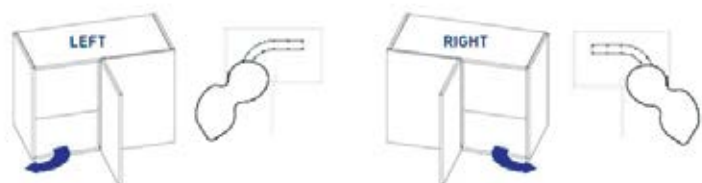



DESCRIPTION	CODE	+	ADD	SIZE	FINISH
			NOVA PRO RUNNER		
SOLID BASE PULL-OUT	002+GRASS		F101108277L X 2	150 MM	CHROME
SOLID BASE PULL-OUT	002+GRAPHITE		F101108277L X 2	150 MM	GRAPHITE

DESCRIPTION	CODE		SIZE	FINISH
BOTTLE RACK DIVIDER KIT	065+		150 MM	CLEAR

FEATURES:

- Soft-close
- Weight capacity - 40 kg
- Full extension drawer slide
- Fully synchronised
- Solid base
- Available in Chrome and Graphite
- Access from both sides
- Left hand runner mounting



DESCRIPTION	CODE	+	ADD	SIZE	FINISH
			NOVA PRO RUNNER		
SOLID BASE PULL-OUT	004+GRASS		F101108276211	300 MM	CHROME
SOLID BASE PULL-OUT	004+GRAPHITE		F101108276211	300 MM	GRAPHITE

DESCRIPTION	CODE		SIZE	FINISH
BOTTLE RACK DIVIDER KIT	066+		300 MM	CHROME
BOTTLE RACK DIVIDER KIT	066+GREY		300 MM	GRAPHITE

FEATURES: Soft-close or Push to open
 Weight capacity - 40 kg
 Full extension drawer slide
 Fully synchronised
 Solid base
 Available in Chrome and Graphite



DESCRIPTION	CODE	SIZE	FINISH
LAUNDRY BIN (RUNNERS INCLUDED)	590	W 450 MM	WHITE BASKET / DARK GREY FRAME

FEATURES: Soft-close
 Over extension runners
 40 kg carrying capacity
 Runners included



DESCRIPTION	CODE	+	ADD	+	ADD	FINISH
			NOVAPRO RUNNER		NOVAPRO SIDES	
SINK DRAWER 900 MM	720A / 900GRP		F101108276211		F100103123211	GRAPHITE



FEATURES: Undersink organising
 2 movable trays and dividers
 Sheet metal base
 Installation to drawer front with screws
 Works with Nova Pro Scala runner and drawer sides



DESCRIPTION	CODE	FINISH
UTILITY BIN DRAWER 900 MM	720B / 900GRP	GRAPHITE



FEATURES: Can be used for recycling or organising
 Installation inside the drawer
 Fits Nova Pro Scala 900 mm drawer box
 Total bin capacity is 36 L
 40 kg or 70 kg runner option



DESCRIPTION	CODE	FINISH
BASE TRAY 900 MM	098 / 900GRP	GRAPHITE
PLATE HOLDER METAL	097P	GRAPHITE
BOWL HOLDER METAL	097C	GRAPHITE



FEATURES: Organising drawer for plates, bowls, cups and glasses
 Installation inside the drawer
 Fits a Nova Pro Scala 900 mm drawer box
 Dismountable to contain the spread of bacteria
 40 kg or 70 kg runner option



DESCRIPTION	CODE	+	ADD NOVA PRO RUNNER	SIZE	CAPACITY
PULL-OUT RECYCLING BIN	564		F101108276211	300 MM	35 LITRES
PULL-OUT RECYCLING BIN	560		F101108276211	400 MM	35 LITRES



FEATURES: Soft-close or Push to open
 Weight capacity - 40 kg
 Full extension drawer slide
 Fully synchronised
 Concealed runner
 Fixed shelf
 Height 560
 Graphite Colour



DESCRIPTION	CODE	+	ADD NOVA PRO RUNNER	SIZE	CAPACITY
PULL-OUT RECYCLING BIN	561		F101108276211	450 MM	70 LITRES
PULL-OUT RECYCLING BIN	562		F101108276211	500 MM	70 LITRES



FEATURES: Soft-close or Push to open
 Weight capacity - 40 kg
 Full extension drawer slide
 Fully synchronised
 Concealed runner
 Fixed shelf
 Height 560
 Graphite Colour



DESCRIPTION	CODE	+	ADD NOVA PRO RUNNER	SIZE	CAPACITY
PULL-OUT RECYCLING BIN	563		F101108276211	600 MM	85 LITRES



FEATURES: Soft-close or Push to open
 Weight capacity - 40 kg
 Full extension drawer slide
 Fully synchronised
 Concealed runner
 Fixed shelf
 Height 560
 Graphite Colour



DESCRIPTION	CODE	+	ADD	CAPACITY	FINISH
			NOVAPRO RUNNER 500 MM		
RECYCLING BIN 600 MM	589		F101108276211	80 LITRES	GRAPHITE



FEATURES: 2 Bin solution for a 600 mm unit
80 L bin capacity
40 kg or 70 kg runner option
Also available for Tipmatic or Sensomatic



DESCRIPTION	CODE	+	ADD	FINISH
			NOVAPRO RUNNER 450 MM	
UNDERSINK BIN 600 MM	700B		F101108273211	GRAPHITE / GREY



FEATURES: Fits under a sink for a 600 mm unit
40 kg or 70 kg runner option
36 L bin capacity
Runner length of 450 mm



DESCRIPTION	CODE	SIZE	CAPACITY
AUTO OPEN BIN BASE MOUNT	520	450 MM	32 LITRES



FEATURES: Opens with the door
Base mounted
Double bin
Fits under sink
Height - 380 mm
Bin Depth - 460 mm
Grey and white colour



DESCRIPTION	CODE	SIZE	CAPACITY
PULL-OUT WASTE BIN BASE MOUNT	540	300 MM	21 LITRES



FEATURES: Base mounted
Fits under sink
Height - 400 mm
Bin Depth - 460 mm
Grey and white colour



DESCRIPTION	CODE	COLOUR	CAPACITY
SIGE TOMMI WASTE BIN	501	GREY	24 LITRES



FEATURES: Door mounted
Easy installation
Includes lid and frame
Height: 440 mm
Bin Depth: 230 mm
Width: 290 mm



DESCRIPTION	CODE	COLOUR	CAPACITY
SIGE WASTE BIN LOOSE	560/LID	GRAPHITE	35 LITRES

FEATURES: Allow for custom built bin drawers
Includes lid to lock out odours
Height: 540 mm
Bin Depth: 240 mm
Width: 375 mm



DESCRIPTION	CODE	SIZE	CAPACITY
COUNTER TOP BIN	IRC005PP	300 MM	8 LITRE

FEATURES: Bin intergrated into counter top
Removeable
Easy access



DESCRIPTION	CODE	SIZE			FINISH
		W	D	H	
WASTE BIN 45 L + LID	H6245	380	330	660	GREY
BIN BRACKET FOR 45L BIN	B/BIN BRACKET				WHITE
FLAP STAY	356.050.00.0070				CHROME



DESCRIPTION	CODE	SIZE	FINISH
KPUSH TECH WITH BUFFER STRONG	57008080AB	70 MM	WHITE
MOUNTING PLATE WITH HOUSING	57010040	80 MM	WHITE
KPUSH TECH WITH BUFFER STRONG	57008080EE	70 MM	GRAPHITE
MOUNTING PLATE WITH HOUSING	57010040G	80 MM	GRAPHITE



DESCRIPTION	CODE	SIZE	FINISH
KPUSH TECH WITH BUFFER NORMAL	57008040AB	70 MM	WHITE
MOUNTING PLATE WITH HOUSING	57010040	80 MM	WHITE
KPUSH TECH WITH BUFFER NORMAL	57008040EE	70 MM	GRAPHITE
MOUNTING PLATE WITH HOUSING	57010040G	80 MM	GRAPHITE



DESCRIPTION	CODE	SIZE	FINISH
KPUSH TECH WITH MAGNET + SCREW	57008020	70 MM	WHITE
MOUNTING PLATE WITH HOUSING	57010040	80 MM	WHITE
KPUSH TECH WITH MAGNET + SCREW	57008020G	70 MM	GRAPHITE
MOUNTING PLATE WITH HOUSING	57010040G	80 MM	GRAPHITE





DESCRIPTION	CODE	FINISH
LIBRA H11 BRACKET SET	C010002380	STEEL
COVER CAP WHITE L	63490710AB	WHITE
COVER CAP WHITE R	63490720AB	WHITE
COVER CAP GRAPHITE L	63490710EE	GRAPHITE
COVER CAP GRAPHITE R	63490720EE	GRAPHITE



FEATURES:

Used for any type of furniture: living room, kitchen and bathroom
Adjustment is easy accessible
Depth and vertical adjustment

Red bolt is a lock device for unit
Very high load capacity of between 120 kg - 200 kg
*Depends on cabinet size, quality of wood, wall quality etc.

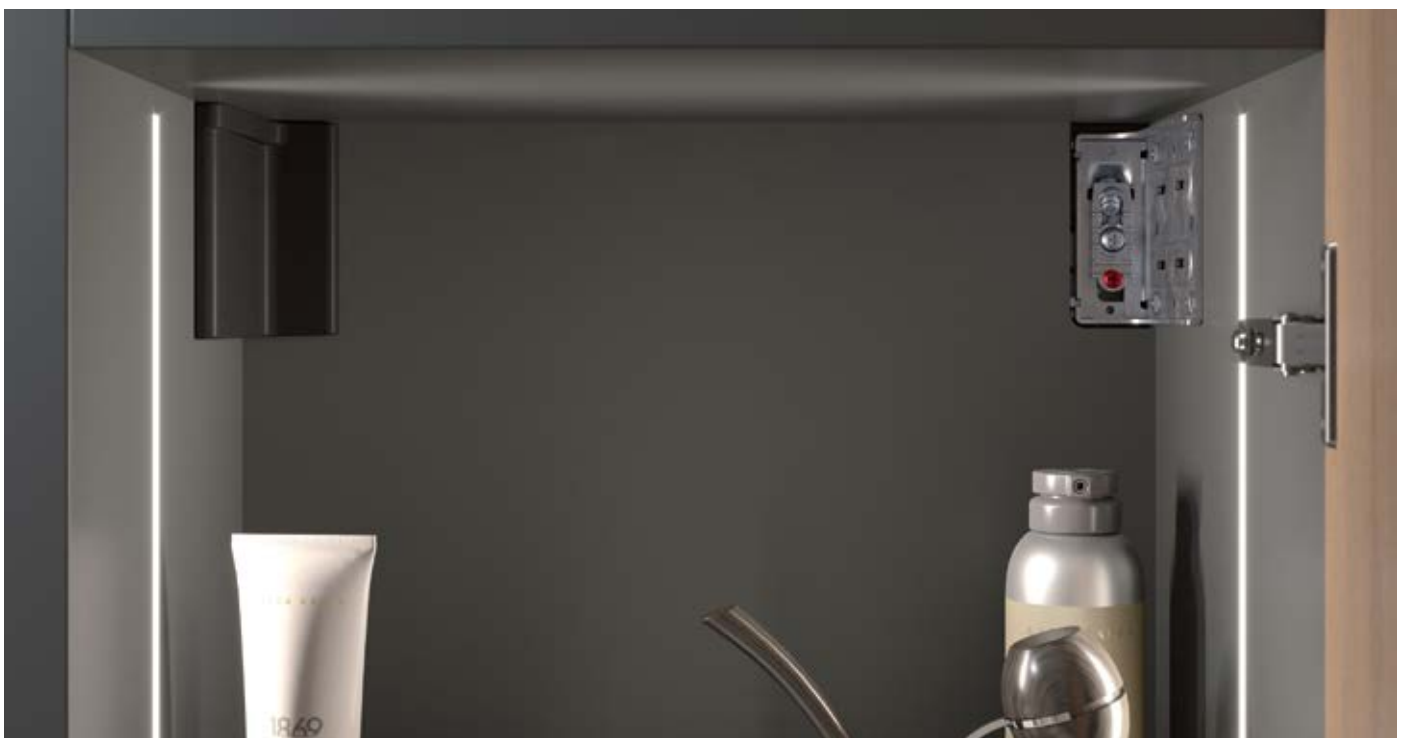



DESCRIPTION	CODE	FINISH
SHELF SUPPORT GLASS WITH RUBBER	10208030YA	NICKEL
SHELF SUPPORT GLASS WITH RUBBER	10208030YQ	NIGHT
SHELF SUPPORT WOOD - NO RUBBER	10208020YA	NICKEL
SHELF SUPPORT WOOD - NO RUBBER	10208020YQ	NIGHT
RUBBER PAD ONLY	10208060AA	CLEAR

	DESCRIPTION	CODE
	SHELF SUPPORT CLEAR SHELF SUPPORT WHITE	517.006.00.0051 517.006.61.0051
	SHELF SUPPORT NICKEL	F069073459253
	SHELF SUPPORT GLASS	517.206.65.0015
	SHELF SUPPORT PIN	517.006.01.0015

FEATURES:

New modern design
Use for glass or wood shelves
Bespoke layer of rubber can be added or removed

Ø 5 mm pin size

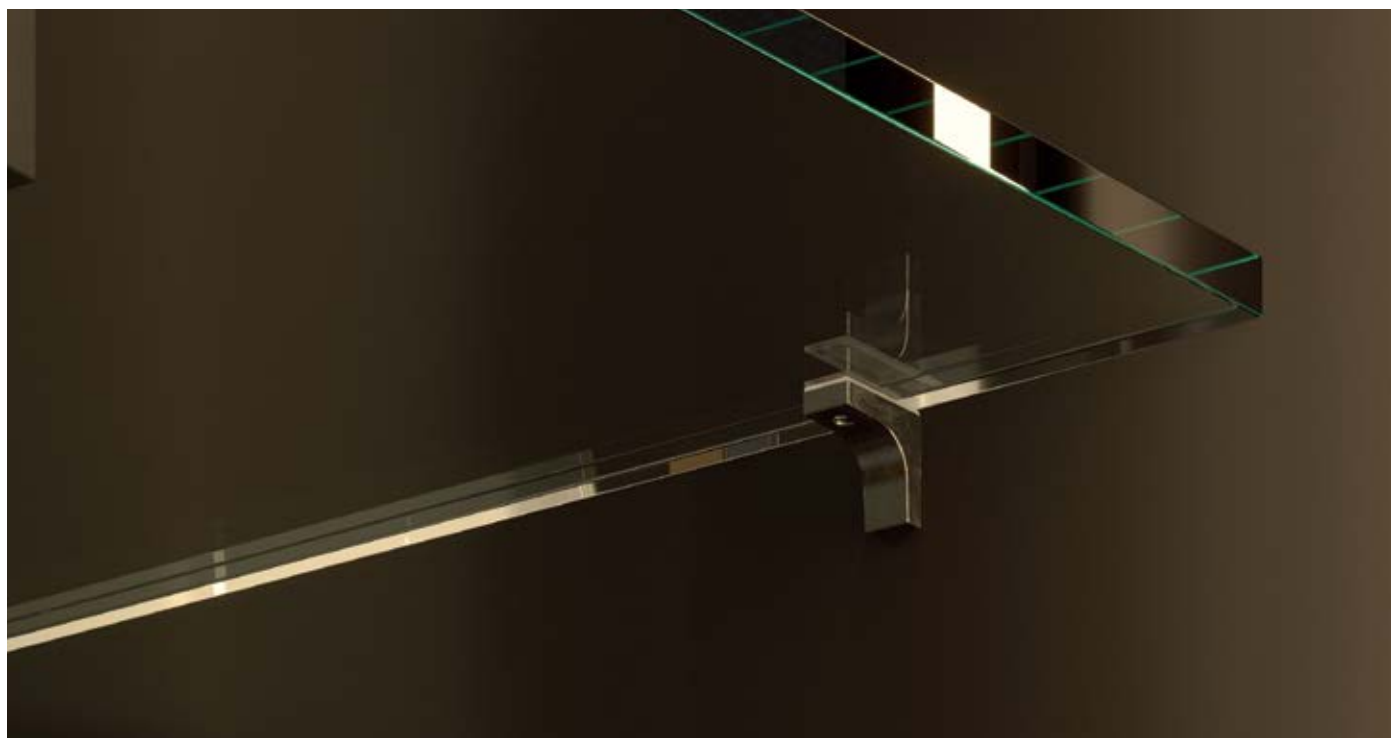



DESCRIPTION	CODE	SIZE	FINISH
WARDROBE LIFT - 15 KG	W/SUPER LIFT/BLK	750 - 1150 MM	BLACK



DESCRIPTION	CODE	SIZE	FINISH
WARDROBE LIFT - 20KG	W/SUPER LIFT	750 - 1150 MM	GREY





DESCRIPTION	CODE	SIZE	FINISH
RECESSING DOOR SYS HEAVY DUTY+HINGES+BAR	KV8092/500	500 MM	BLACK
RECESSING DOOR SYS HEAVY DUTY+HINGES+BAR	KV8092/600	600 MM	BLACK

FEATURES: Height up to 2000 mm
 Door thickness up to 22 mm
 Gear system
 No Sagging of doors

Up to 2500mm if you add centre pocket slide
 Up to a maximum weight capacity of 35 Kg per door
 Inset or overlay of 6 mm application only



DESCRIPTION	CODE	SIZE	FINISH
SHOE PULLOUT ADJ 600 - 750 MM	B/SHOE P/O 600WHT	450 MM X 170 MM	WHITE
SHOE PULLOUT ADJ 600 - 750 MM	B/SHOE P/O 600GRP	450 MM X 170 MM	GRAPHITE
SHOE PULLOUT ADJ 750 - 900 MM	B/SHOE P/O 750WHT	450 MM X 170 MM	WHITE
SHOE PULLOUT ADJ 750 - 900 MM	B/SHOE P/O 750GRP	450 MM X 170 MM	GRAPHITE



DESCRIPTION	CODE	SIZE	FINISH
COAT RAIL OVAL	B/RAIL	15 MM X 30 MM X 2500 MM	CHROME
ROD HOLDER	B/ROD HOLDER	15 MM X 45 MM	CHROME
CENTRE SUPPORT	B/HOLDER SUPPORT	15 MM X 70 MM	CHROME
COAT RAIL OVAL BLACK	B/RAIL BLK	15 MM X 30 MM X 2500 MM	BLACK
ROD HOLDER BLACK	B/ROD HOLDER BLK	15 MM X 45 MM	BLACK
CENTRE SUPPORT BLACK	B/HOLDER SUPPORT BLK	15 MM X 70 MM	BLACK
ROD HOLDER BLACK B/FIX	B/ROD HOLDER BLK B/FIX	15 MM X 65 MM	BLACK
HANGING ROD HOLDER (PAIR)	VW009_BLK	15 MM X 110 MM	BLACK



DESCRIPTION	CODE	SIZE	FINISH
OVAL RAIL	B/RAIL ALU	19 MM X 34 MM X 3000 MM	ALU
HANG RAIL BRACKET	T128W	20 MM X 35 MM	WHITE





DESCRIPTION	CODE	SIZE	FINISH
CHROME WIRE BASKET	V/B400C	400 MM CARCASS	CHROME
CHROME WIRE BASKET	V/B450C	450 MM CARCASS	CHROME
CHROME WIRE BASKET	V/B500C	500 MM CARCASS	CHROME
CHROME WIRE BASKET	V/B600C	600 MM CARCASS	CHROME

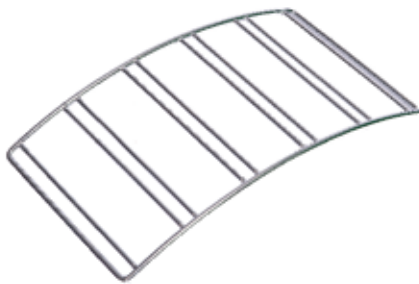

DESCRIPTION	CODE	SIZE	FINISH
CURVED WINE BOTTLE RACK	WR240D	400 MM	CHROME
CURVED WINE BOTTLE RACK	WR250D	500 MM	CHROME
CURVED WINE BOTTLE RACK	WR260D	600 MM	CHROME



DESCRIPTION	CODE	SIZE	FINISH
VOLPATO LEG	C/LEG 100P	100 MM	BLACK
VOLPATO LEG	C/LEG 150P	150 MM	BLACK
SKIRTING CLIP WOOD	C/CLIP/P	-	BLACK
SKIRTING CLIP ALU	C/CLIP/K	-	BLACK



DESCRIPTION	CODE	SIZE	FINISH
BRUSHED ALU KICK PLATE 100 MM X 4 M	AKP 100 BRU	100 MM	BRUSHED ALU
BRUSHED ALU KICK PLATE 150 MM X 4 M	AKP 150 BRU	150 MM	BRUSHED ALU
BRUSHED ALU KICK PLATE 100 MM FLEXIBLE CORNER	AKP 100 BRU FLEX CNR	100 MM	BRUSHED ALU
BRUSHED ALU KICK PLATE 150 MM FLEXIBLE CORNER	AKP 150 BRU FLEX CNR	150 MM	BRUSHED ALU
BRUSHED ALU KICK PLATE 100 MM 90 DEG FIXED CORNER	AKP 100 BRU 90 DEG CNR	100 MM	BRUSHED ALU
BRUSHED ALU KICK PLATE 150 MM 90 DEG FIXED CORNER	AKP 150 BRU 90 DEG CNR	150 MM	BRUSHED ALU



DESCRIPTION	CODE	SIZE			FINISH
		W	X	D X H	
OMNI TRAP COVER	TRAP/SHELF COVER WHITE	240 MM	X 120 MM	X 83 MM	WHITE
OMNI TRAP COVER	TRAP/SHELF COVER GREY	240 MM	X 120 MM	X 83 MM	GREY



DESCRIPTION	CODE	SIZE			FINISH
		W	X	H	
VOLPATO TRAP COVER	35101660WH	680 MM	X 78 MM		WHITE
VOLPATO TRAP COVER	35101660SIL	680 MM	X 78 MM		GREY
VOLPATO TRAP COVER	35101660GRP	680 MM	X 78 MM		GRAPHITE





DESCRIPTION	CODE	SIZE	FINISH
		W X H	
OMNI SPICE TRAY	OST/450GRP	387 MM X 480 MM	GRAPHITE
OMNI SPICE TRAY	OST/450WH	387 MM X 480 MM	WHITE
OMNI SPICE TRAY	OST/500GRP	437 MM X 480 MM	GRAPHITE
OMNI SPICE TRAY	OST/500WH	437 MM X 480 MM	WHITE
OMNI SPICE TRAY	OST/600GRP	537 MM X 480 MM	GRAPHITE
OMNI SPICE TRAY	OST/600WH	537 MM X 480 MM	WHITE



DESCRIPTION	CODE	FINISH
GAS LIFT 80N SOFT-CLOSE WOOD	MZ3212	STEEL
GAS LIFT 100N SOFT-CLOSE WOOD	MZ3213	STEEL
GAS LIFT 120N WOOD	MZ3214	STEEL
GAS LIFT 150N WOOD	MZ3215	STEEL
GAS LIFT ALU 80N	MZ6146	STEEL
GAS LIFT ALU 100N	MZ6147	STEEL



DESCRIPTION	CODE	FINISH
MAXI B LIFT	MAXI.B	STEEL
MAXI C LIFT	MAXI.C	STEEL



DESCRIPTION	CODE	SIZE	FINISH
BROOM CLIP	BROOM CLIP	20 - 30 MM	BLACK



DESCRIPTION	CODE	SIZE	FINISH
TOP CABINET SUSPENSION FITTING	F155145207210	130 KG CAPACITY	STEEL
TOP CABINET SUSPENSION RAIL	F155145236513	125 MM	STEEL



DESCRIPTION	CODE	SIZE	FINISH
STICK ON DOOR BUMPER	F146073835253	7 MM	CLEAR
STICK ON DOOR BUMPER	F146073836256	10 MM	CLEAR
DOOR BUMPER DRILL IN	630.000.03.0850	5 MM	CLEAR



DESCRIPTION	CODE	SIZE	FINISH
CAMFIX METAL	T3201	20 Ø X 13 MM	NICKLE
CAMFIX PLASTIC	T3201B	20 Ø X 13 MM	BROWN
CAMFIX PLASTIC	T3201W	20 Ø X 13 MM	WHITE



DESCRIPTION	CODE	SIZE	FINISH
WEDGEFIX	T3241	20 Ø X 12 MM	WHITE
WEDGEFIX	T3241B	20 Ø X 12 MM	BROWN



DESCRIPTION	CODE	SIZE	FINISH
DOWEL 5 MM EURO	T3400	5 Ø X 11 MM	ZINC
DOWEL 5 MM EURO SHORT	T3410	5 Ø X 7.5 MM	ZINC



DESCRIPTION	CODE	SIZE	FINISH
DOWEL M4	T3470.009	M4 X 7.5 MM	ZINC



DESCRIPTION	CODE	SIZE	FINISH
SLEEVE	T3051	5 Ø X M4 X 15 MM	RAW



DESCRIPTION	CODE	SIZE	FINISH
CAM FITTING 15 MM	T3150	15 Ø X 15 MM	ZINC



DESCRIPTION	CODE	SIZE	FINISH
DOWELL FITTING WITH SLEEVE	CB2620	50 X 34 MM	STEEL



DESCRIPTION	CODE	SIZE	FINISH
DOWEL STEEL M6	T3462	M6 X 34 MM	RAW
DOWEL STEEL M4	T3470	M4 X 34 MM	RAW



DESCRIPTION	CODE	SIZE	FINISH
QUICKFIT BOLT 8 X 34 MM EXPANDING DOWEL	T3491	8 Ø X 34 MM	ZINC



DESCRIPTION	CODE	SIZE		FINISH
		W	H	
KD 9000 BIC PIN	F148043053123	-	-	NICKEL
KD 9000 BIC SHELF SUPPORT	F148043036551	-	-	NICKEL
KD 9000 BIC HOUSING	F148043056123	19 MM	8 MM	WHITE



DESCRIPTION	CODE	SIZE	FINISH
EURO SCREW COUNTERSUNK	707.360.61.1015	6 MM X 10 MM	NICKEL
EURO SCREW COUNTERSUNK	707.360.61.3015	6 MM X 13 MM	NICKEL
EURO SCREW PAN HEAD	707.362.61.3015	6 MM X 13 MM	NICKEL
EURO SCREW COUNTERSUNK FOR GRASS PRODUCTS	F145083544599	6 MM X 11.5 MM	NICKEL



DESCRIPTION	CODE	SIZE	FINISH
CONNECTING SCREW 5 MM	499.040.27.0025	32 MM X 5 MM	NICKEL



INNOVATION AND TRADITION

We are pioneers.

75 years of pioneering spirit.

Whether unique movement systems or elegant opening systems for handle-free fronts: Our fascinating inventions are sustainably changing the world of furniture today - just like they always have.

INNOVATION AND TRADITION

GRASS has always been a pioneer in the furniture industry. From the first concealed hinge to the invention of the double-wall drawer, the history of GRASS has been shaped by visionary engineering expertise and countless groundbreaking products.

www.grass.eu

G*GRASS®



GRASS supplies
the leading furniture
manufacturers
in the world.



GOOD DESIGN.

 @grassmovementsystems

 /grassza

 /GRASSZA

 /grassmovementsystems

www.grass.eu

GRASS ZA (PTY) LTD.

2 Graph Avenue
Montague Gardens
Cape Town, South Africa

T +27 21 529 8040
F +27 21 529 8041
info@grass.co.za

Unit 6, Northlands Retail Park
Epsom Road, North Riding
Johannesburg 2169, South Africa

T +27 11 801 9500